

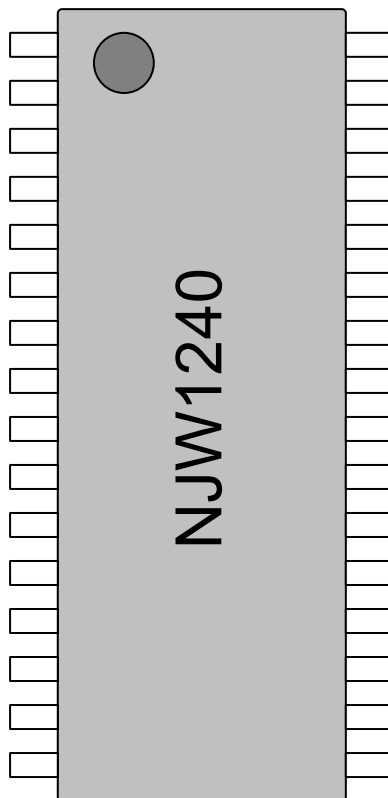

# NJW1240

## ■ PIN CONFIGURATION



No.	Symbol	Function	No.	Symbol	Function
1	IN1	Input 1	17	NC	No Connect
2	IN2	Input 2	18	FB	V- Power Supply External Setting
3	IN3	Input 3	19	CP	Flying Capacitor Positive Terminal
4	IN4	Input 4	20	NC	No Connect
5	IN5	Input 5	21	NC	No Connect
6	IN6	Input 6	22	GND	Ground
7	MUTE	MUTE / Pop Noise Suppression	23	CN	Flying Capacitor Negative Terminal
8	GAIN	Gain Select	24	MUTE_TC	Pop Noise Suppression Capacitor
9	V <sup>-</sup> IN	V- Power Input	25	V <sup>+</sup> A	V+ Power Supply for Analog
10	V <sup>-</sup> OUT	V- Power Output	26	GND	Ground
11	RegCNT	V- Power Control	27	OUT6	Output 6
12	NC	No Connect	28	OUT5	Output 5
13	NC	No Connect	29	OUT4	Output 4
14	CLK	External Clock Input	30	OUT3	Output 3
15	V <sup>+</sup> Reg	V+ Power Supply for Regulator	31	OUT2	Output 2
16	NC	No Connect	32	OUT1	Output 1

## ■ ABSOLUTE MAXIMUM RATING (Ta=25°C)

PARAMETER	SYMBOL	RATING	UNIT
Supply Voltage	V <sup>+</sup>	10.5	V
CLK Terminal Voltage	V <sub>CLK</sub>	-0.3~+6	V
V <sup>-</sup> Power Supply Control Voltage	V <sub>RegCNT</sub>	-0.3~+6	V
FB Terminal Voltage	V <sub>FB</sub>	(V <sub>OUT</sub> )+6	V
Maximum Input Voltage	V <sub>IN</sub>	V <sup>+</sup> +0.3	V
Power Dissipation	P <sub>D</sub>	905 <sup>(Note1)</sup>	mW
Operating Temperature Range	Topr	-40 ~ +85	°C
Storage Temperature Range	Tstg	-40 ~ +125	°C

(Note1) EIA/JEDEC STANDARD Test board (76.2x114.3x1.6mm, 2layer, FR-4) mounting

## ■ RECOMMENDED OPERATING CONDITIONS

(Ta=25°C unless otherwise specified)

PARAMETER	SYMBOL	TEST CONDITION	MIN.	TYP.	MAX.	UNIT
Operating Voltage	V <sup>+</sup>		6	8	10	V
External Clock Input Range <sup>(Note2)</sup>	f <sub>CLK</sub>		150	-	1250	kHz
External Clock Duty Input Range	DUTY		45	-	80	%

(Note2) The regulator for V<sup>-</sup> power supply operates by the half of f<sub>CLK</sub>.

## ■ ELECTRICAL CHARACTERISTICS

(Ta=25°C, V<sup>+</sup>=8V, f=1kHz, Vin=0dBV, R<sub>L</sub>=47kΩ, GAIN=Low, MUTE=High, RegCNT=High unless otherwise specified)

PARAMETER	SYMBOL	TEST CONDITION	MIN.	TYP.	MAX.	UNIT
Operating Current	I <sub>DD</sub>	No signal	-	12	20	mA
Voltage Gain1	G <sub>V1</sub>		5.5	6.0	6.5	dB
Voltage Gain2	G <sub>V2</sub>	GAIN=High	7.8	8.3	8.8	dB
Maximum Output Voltage	V <sub>OMAX</sub>	THD=1%	5	-	-	V <sub>rms</sub>
Mute Level	V <sub>MUTE</sub>	MUTE=Low	-	-100	-80	dB
Output Noise Voltage	V <sub>NO</sub>	Rg=0Ω, A=Weighted	-	-102 (7.94)	-	dBV (μV)
Total Harmonic Distortion	THD	BW:400Hz-22kHz	-	0.0008	-	%
Channel Separation	CS	Rg=600Ω	80	-	-	dB
Internal Oscillating Frequency	f <sub>OSC</sub>	f <sub>CLK</sub> =No signal	-	300	-	kHz
Output Offset Voltage	V <sub>OS</sub>	Rg=0Ω	-	-	8	mV

## ■ CONTROL CHARACTERISTICS

(Ta=25°C, V<sup>+</sup>=8V, f=1kHz, Vin=0dBV, R<sub>L</sub>=47kΩ unless otherwise specified)

PARAMETER	SYMBOL	TEST CONDITION	MIN.	TYP.	MAX.	UNIT
Mute Terminal High	Mute <sub>H</sub>	MUTE OFF	2.3	-	V <sup>+</sup>	V
Mute Terminal Low	Mute <sub>L</sub>	MUTE ON	0	-	0.7	V
Gain Terminal High	Gain <sub>H</sub>	Gv=8.3dB	2.3	-	V <sup>+</sup>	V
Gain Terminal Low	Gain <sub>L</sub>	Gv=6dB	0	-	0.7	V
CLK Terminal High	CLK <sub>H</sub>		2.3	-	5.5	V
CLK Terminal Low	CLK <sub>L</sub>		0	-	0.7	V

## ■ TERMINAL DESCRIPTION

Terminal	SYMBOL	FUNCTION	EQUIVALENT CIRCUIT	VOLTAGE
1 2 3 4 5 6	IN1 IN2 IN3 IN4 IN5 IN6	INPUT1 INPUT2 INPUT3 INPUT4 INPUT5 INPUT6		0V
7 8	MUTE GAIN	MUTE/Pop Noise Suppression Gain Select		0V
11	RegCNT	V- Power Control		0V
14	CLK	External Clock Input		0V
18	FB	V- Power Supply External Setting		-

## ■ TERMINAL DESCRIPTION

Terminal	SYMBOL	FUNCTION	EQUIVALENT CIRCUIT	VOLTAGE
19	CP	Flying Capacitor Positive Terminal		-
23	CN	Flying Capacitor Negative Terminal		-
24	MUTE_TC	Pop Noise Suppression Capacitor		0V
27 28 29 30 31 32	OUT6 OUT5 OUT4 OUT3 OUT2 OUT1	Output6 Output5 Output4 Output3 Output2 Output1		0V



## TEST CIRCUIT (V<sub>NO</sub>)

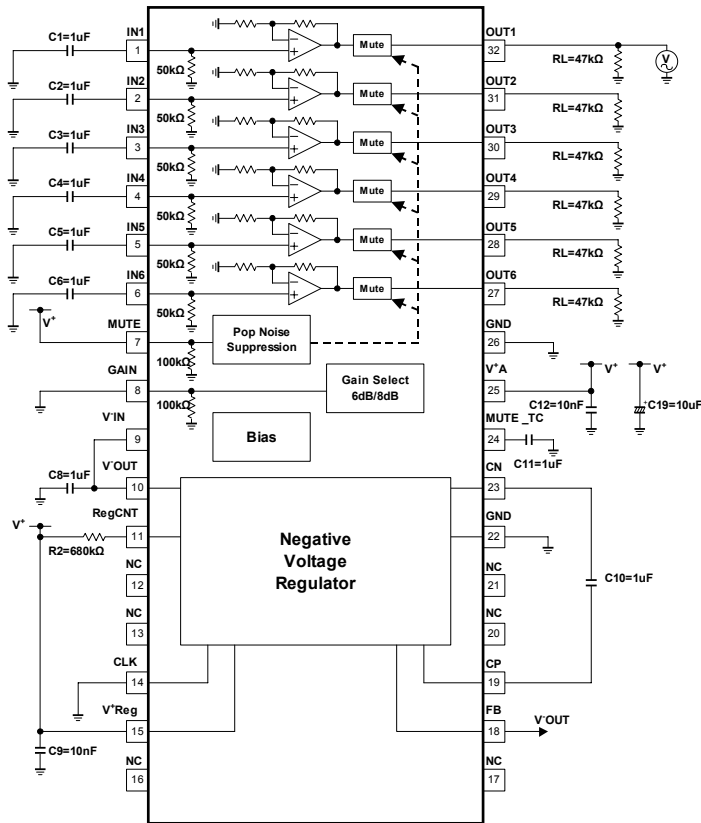

## TEST CIRCUIT (CS)

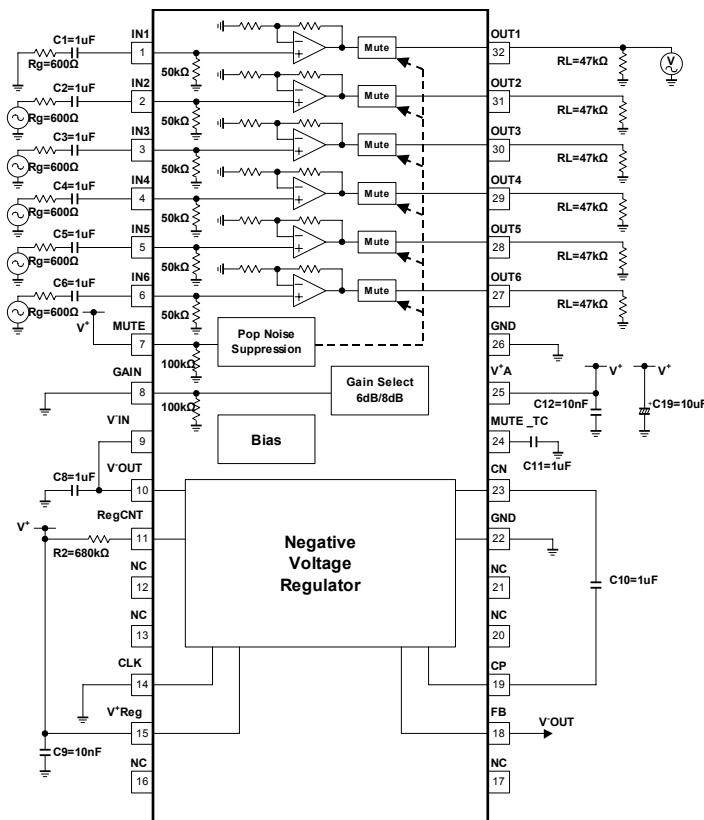

# NJW1240

## APPLICATION CIRCUIT

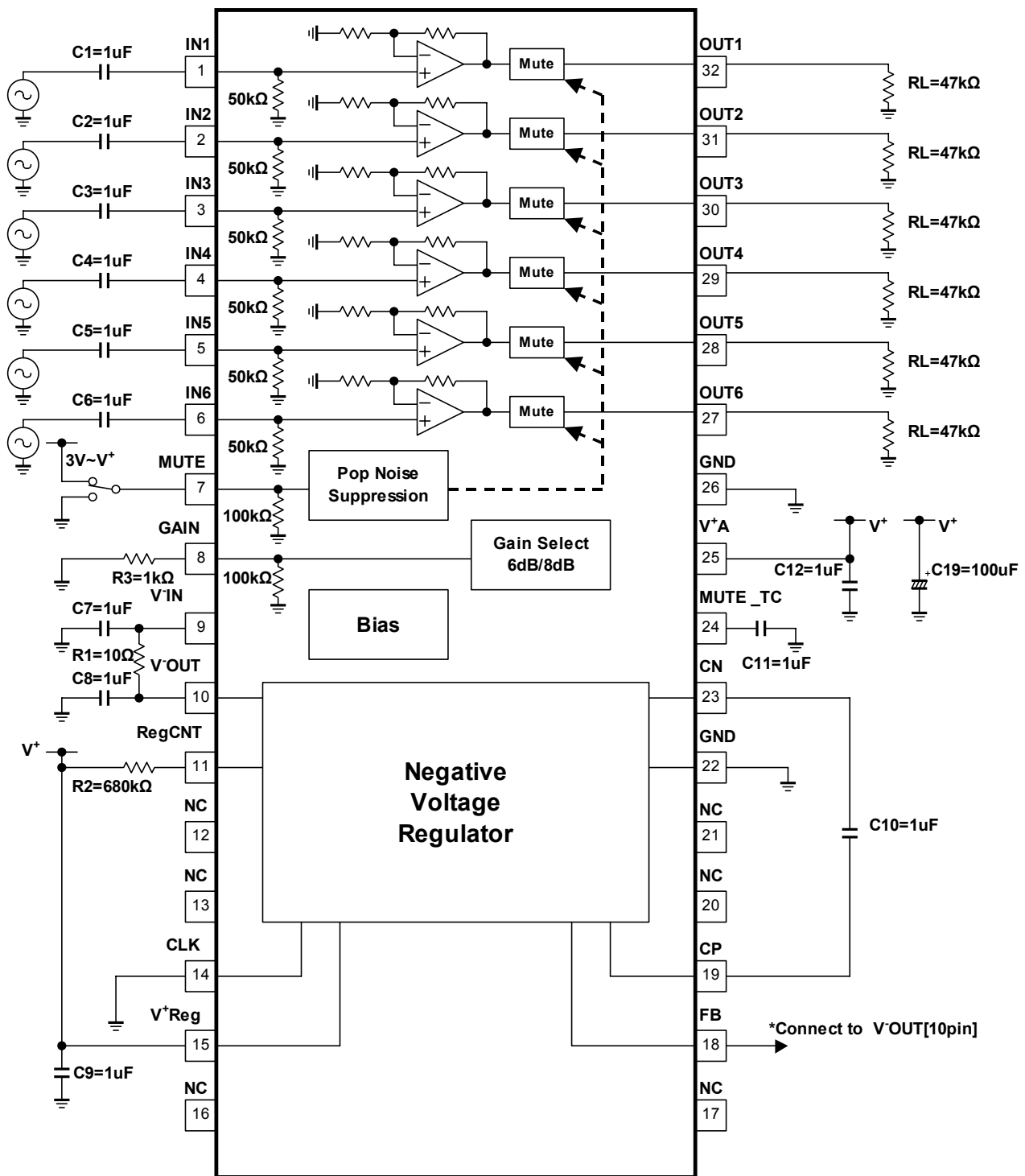



## TYPICAL CHARACTERISTICS

Supply Current vs Supply Voltage  
 RL=NoLoad, MUTE=H, GAIN=L

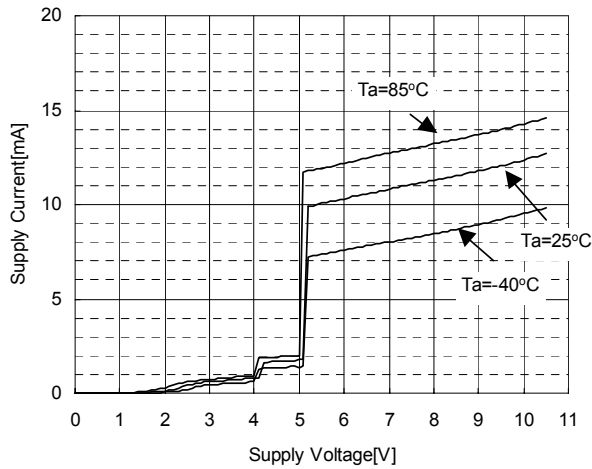

Supply Current vs Temperature  
 V+=8V, RL=NoLoad, MUTE=H, GAIN=L

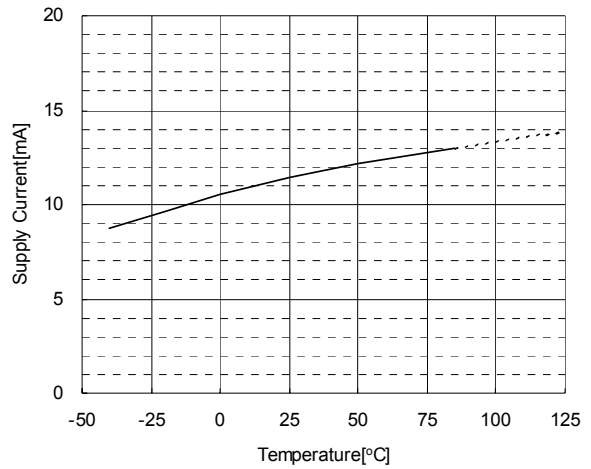

Output DC Offset vs Temperature  
 V+=8V, Vin=NoSignal, RL=47kΩ  
 MUTE=H, GAIN=L

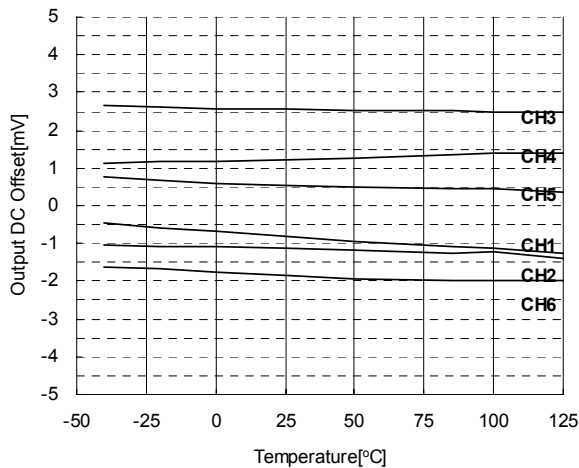

Voltage Gain vs Frequency  
 V+=8V, Vin=0dBV, RL=47kΩ, MUTE=H

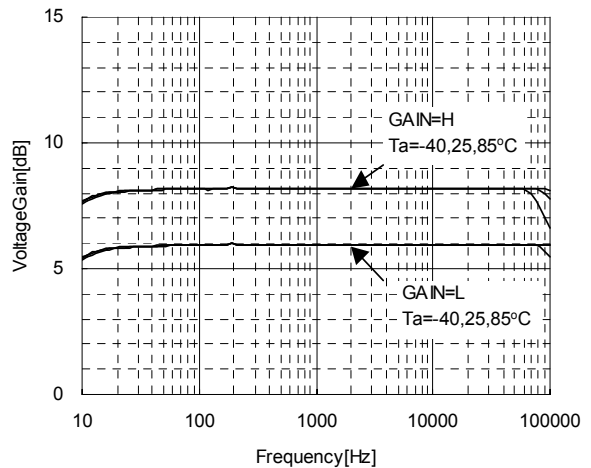

MuteLevel vs Frequency  
 V+=8V, RL=47kΩ, MUTE=L, GAIN=L  
 Filter=Bandpass

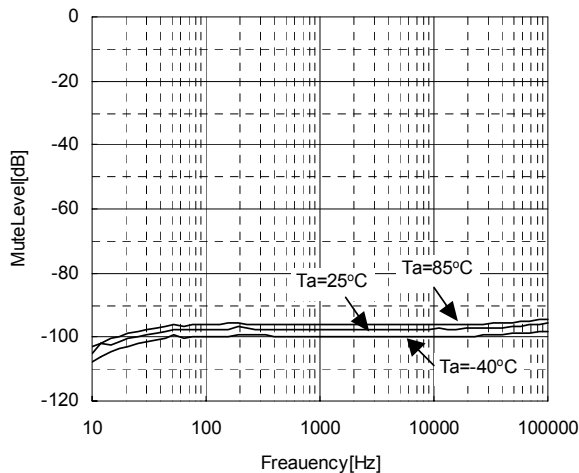

Output Noise vs Temperature  
 V+=8V, Rg=0Ω, RL=47kΩ, MUTE=H, GAIN=L  
 Filter=A-weighted

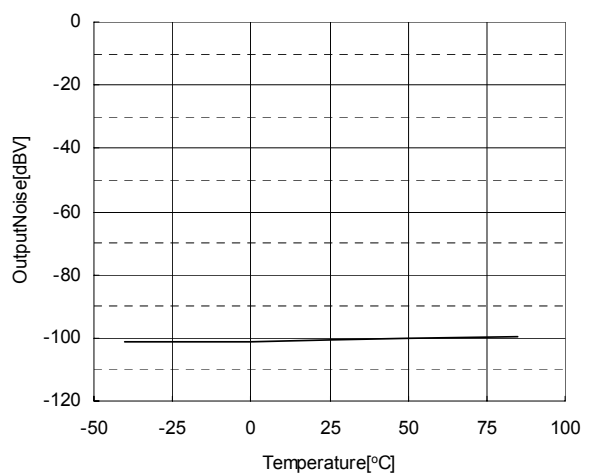

## TYPICAL CHARACTERISTICS

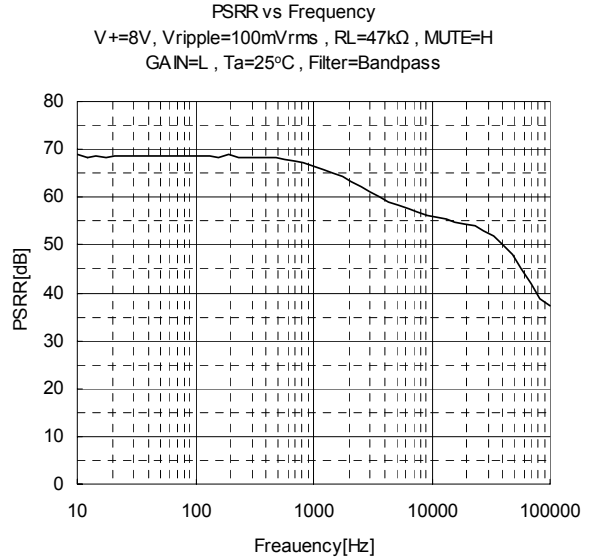
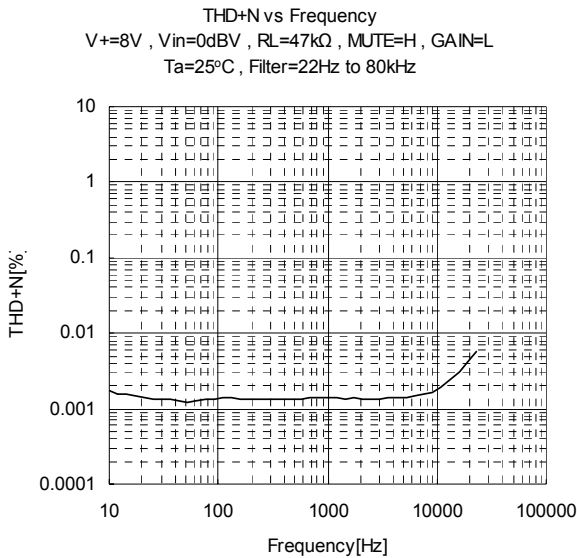
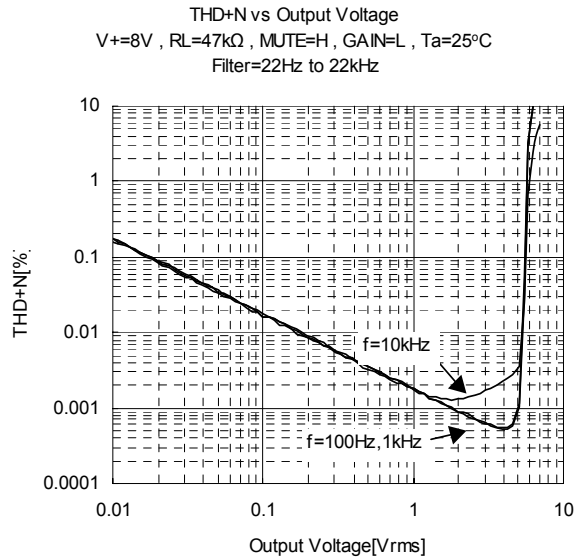
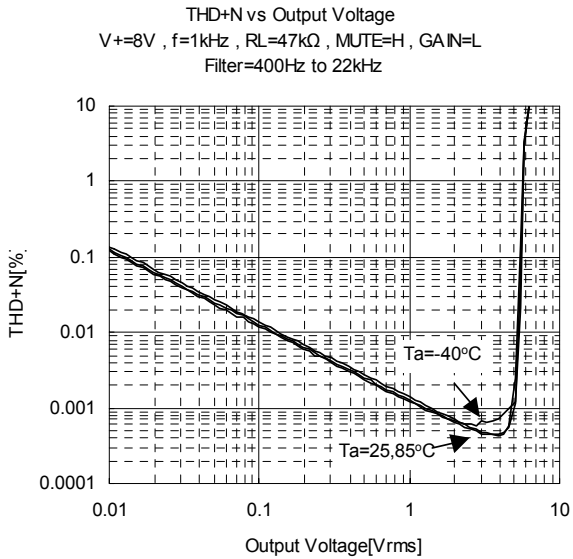
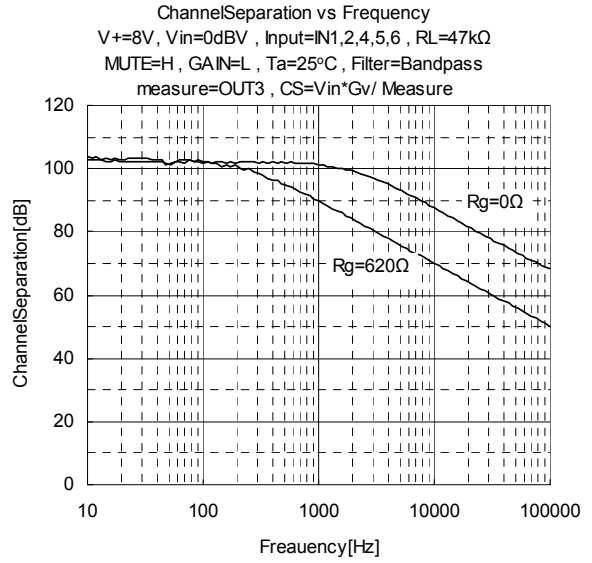
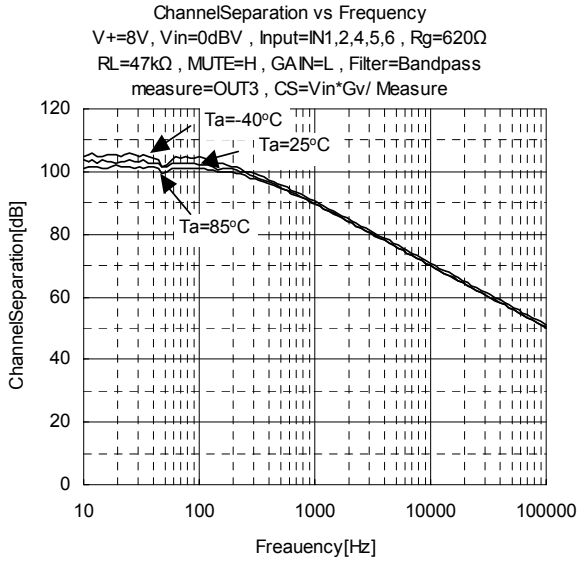

## TYPICAL CHARACTERISTICS

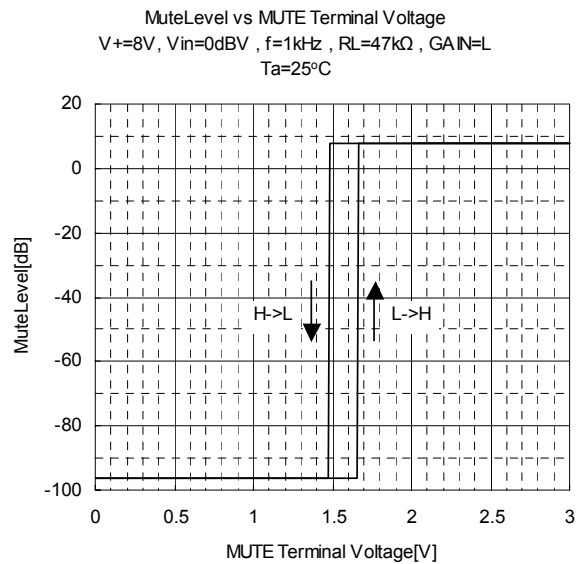
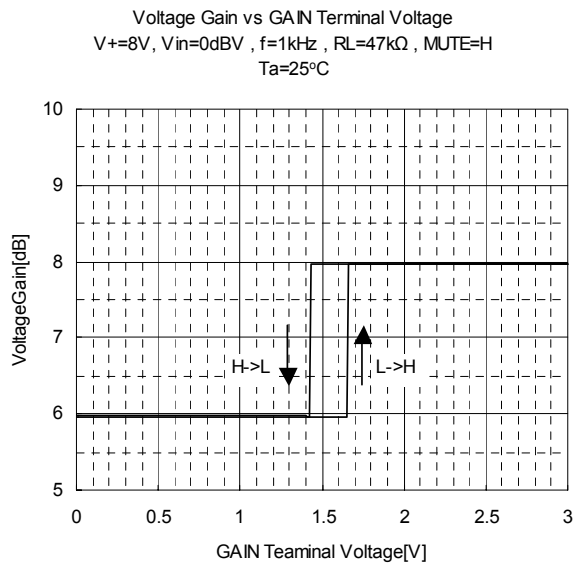
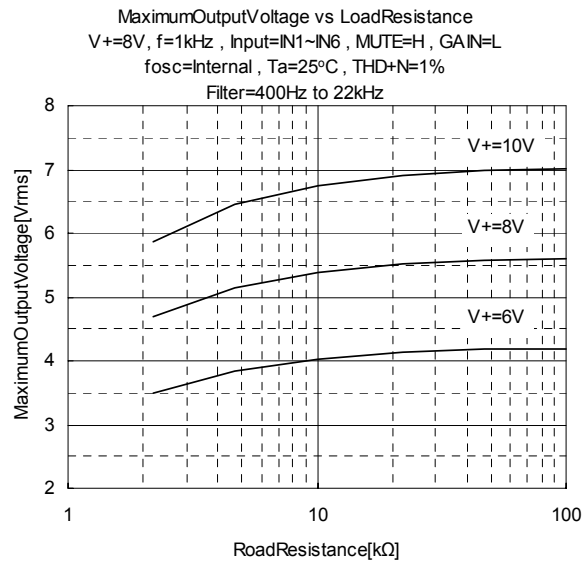
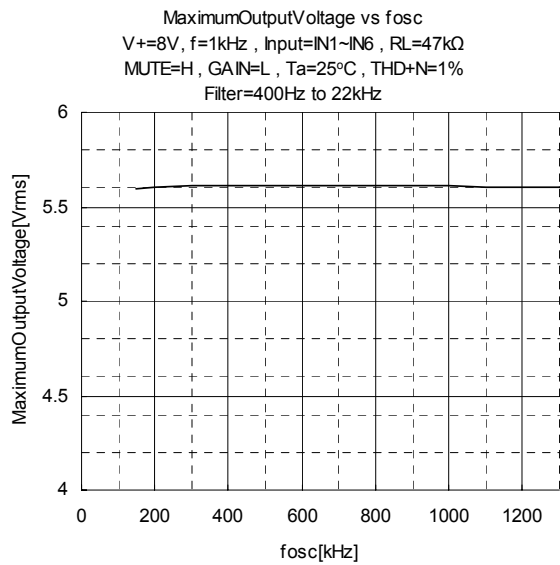
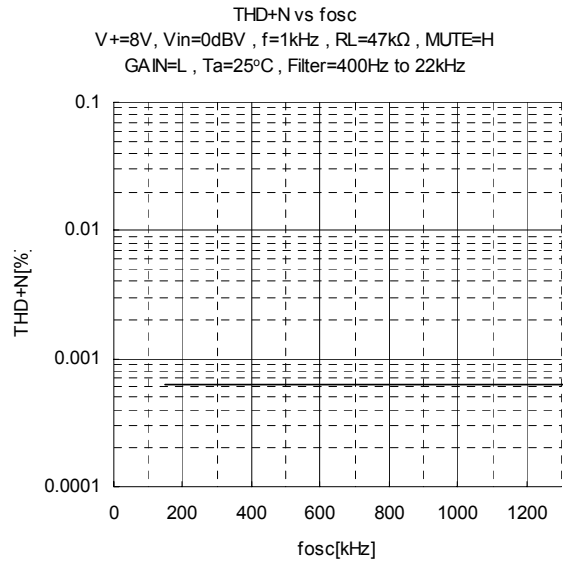
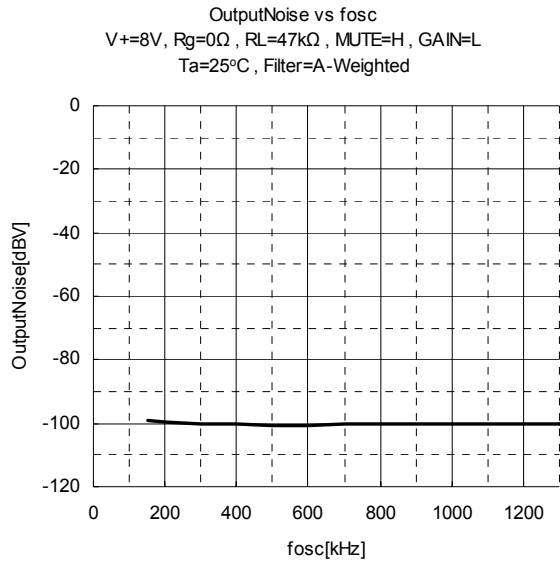

[CAUTION]

The specifications on this databook are only given for information, without any guarantee as regards either mistakes or omissions. The application circuits in this databook are described only to show representative usages of the product and not intended for the guarantee or permission of any right including the industrial rights.