

## VIDEO DIFFERENTIAL INPUT RECEIVER

### ■GENERAL DESCRIPTION

The NJM2507 is video differential input receiver. The differential signal is converted to the single-end signal. The single-end signal can be transmitted by the differential signal by the connection with NJM2504.

And, it is converted to the single-end signal by the NJM2507.

The common mode noise can be removed because of the differential motion transmission, and it is the best for the transmission of car AV system.

### ■PACKAGE OUTLINE



**NJM2507RB1**  
**MSOP8(TVSP8)**

### ■FEATURES

- Operating Voltage 4.5 to 9.5V
- Input: Differential signal, Output: Single-end signal
- Internal 6dB Amplifier \*Differential input mode
- Internal 75ohm Driver
- Internal SAG Correction Circuit
- Bipolar Technology
- Package Outline MSOP8(TVSP8)\*  
\*MEET JEDEC MO-187-DA / THIN TYPE

### ■PIN CONNECTION

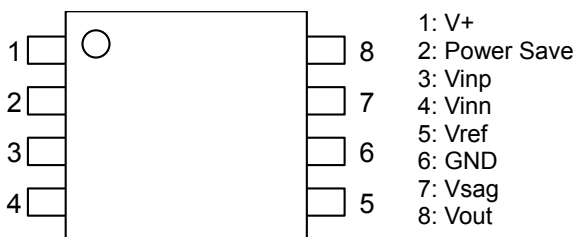

### ■BLOCK DIAGRAM

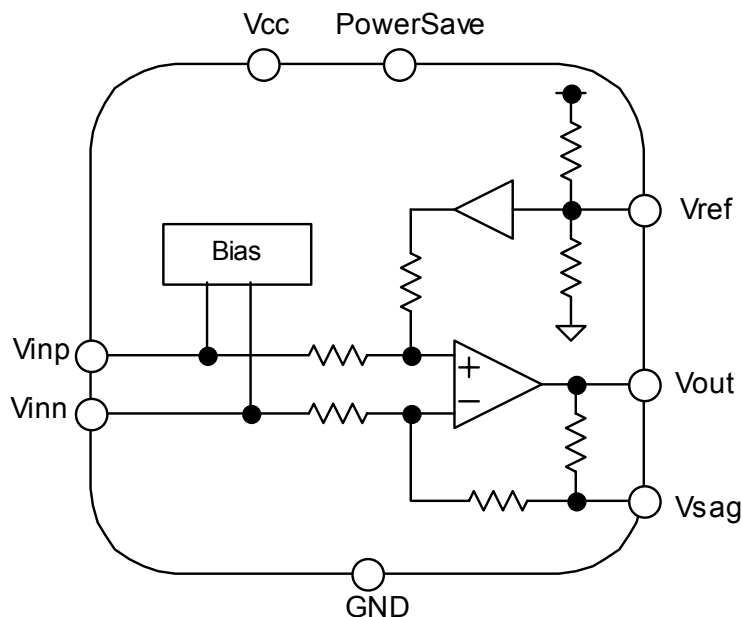

# NJM2507

## ■ABSOLUTE MAXIMUM RATINGS (Ta=25°C)

PARAMETER	SYMBOL	RATINGS	UNIT
Supply Voltage	V <sup>+</sup>	10	V
Power Dissipation	P <sub>D</sub>	580(Note1)	mW
Operating Temperature Range	Topr	-40 to +85(Note2)	°C
Storage Temperature Range	Tstg	-40 to +150	°C

(Note 1) At on a board of EIA/JEDEC specification. (114.3 x 76.2 x 1.6mm 2 layers, FR-4)

(Note 2) It has high operating temperature range product.(-40 to +105°C)

## ■RECCOMENDED OPERATING CONDITIONS (Ta=25°C)

PARAMETER	SYMBOL	TEST CONDITION	MIN.	TYP.	MAX.	UNIT
Operating voltage	Vopr		4.5	-	9.0	V

## ■ELECTRICAL CHARACTERISTICS (V<sup>+</sup> =5V, RL=150ohm, Ta=25°C)

PARAMETER	SYMBOL	TEST CONDITION	MIN.	TYP.	MAX.	UNIT
Supply Current	I <sub>CC</sub>	No signal	-	10	12	mA
Supply Current at Power Save Mode	I <sub>save</sub>	Power save mode	-	0.3	0.5	mA
Maximum Output Level	V <sub>om</sub>	Vin=100kHz, sin-signal, THD=1%,	2.2	2.4	-	Vp-p
Voltage Gain	G <sub>v</sub>	Vin=1MHz, 1.0Vp-p sin-signal	-0.3	0.2	0.7	dB
Frequency Characteristics	G <sub>f</sub>	Vin=10MHz/1MHz, 1.0Vpp sin-signal	-1.0	0	1.0	dB
Common Mode Rejection Ratio	CMR	Vin=20kHz, 1.0Vpp, sin-signal	-	-50	-	dB
Differential Gain	DG	Vin=1.0Vp-p 10step video signal	-	0.5	-	%
Differential Phase	DP	Vin=1.0Vp-p 10step video signal	-	0.5	-	deg
SW Voltage High Level	V <sub>thH</sub>		2.2	-	V <sup>+</sup>	V
SW Voltage Low Level	V <sub>thL</sub>		0	-	1.0	V
SW Sink Current High Level	I <sub>thH</sub>	V=5V	-	-	120	μA
SW Sink Current Low Level	I <sub>thL</sub>	V=0.3V	-	-	8.0	μA

## ■CONTROL CHARACTERISTIC

PARAMETER	STATUS	MODE
Power Save	H	Power save: OFF Active mode
	L	Power save: ON Non-Active mode (Mute)
	OPEN	Power save: ON Non-Active mode (Mute)

## TEST CIRCUIT

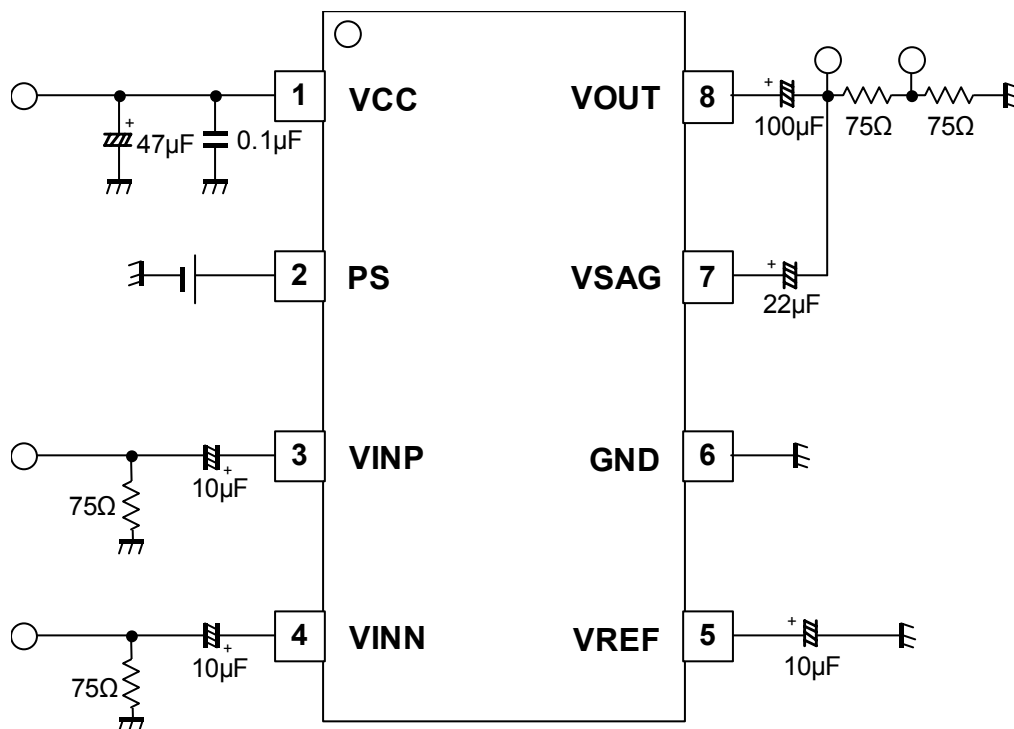

## APPLICATION CIRCUIT

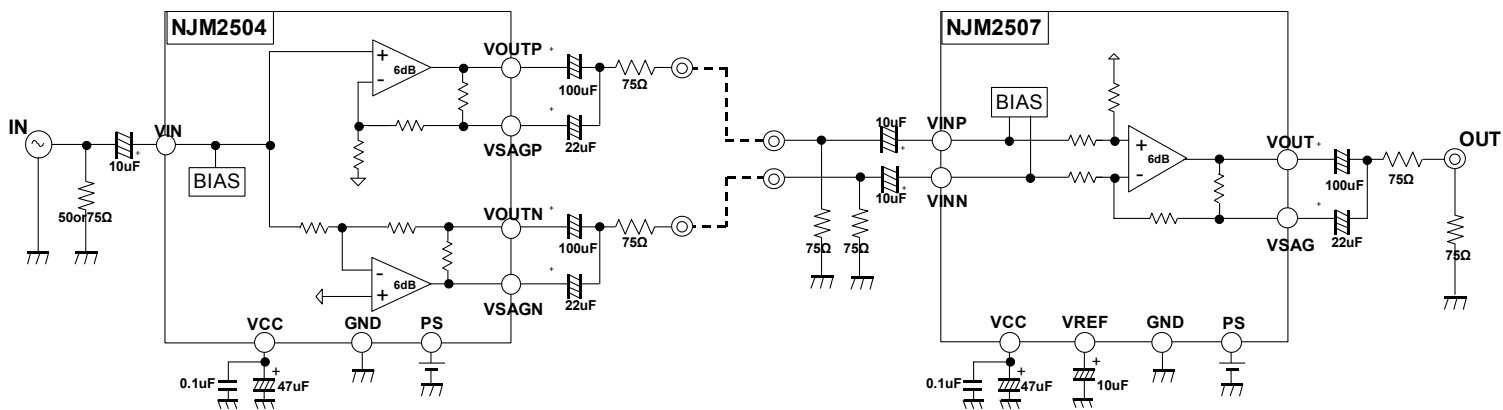

# NJM2507

## APPLICATION CIRCUIT

When the receiver is single end input, the NJM2507 becomes GND noise isolator on the transmitter.

Connect GND of the receiver to Vref terminal of the NJM2507. (Note1)

The NJM2507 outputs signal that has canceled the GND noise, because GND reference is the receiver. (Note2)

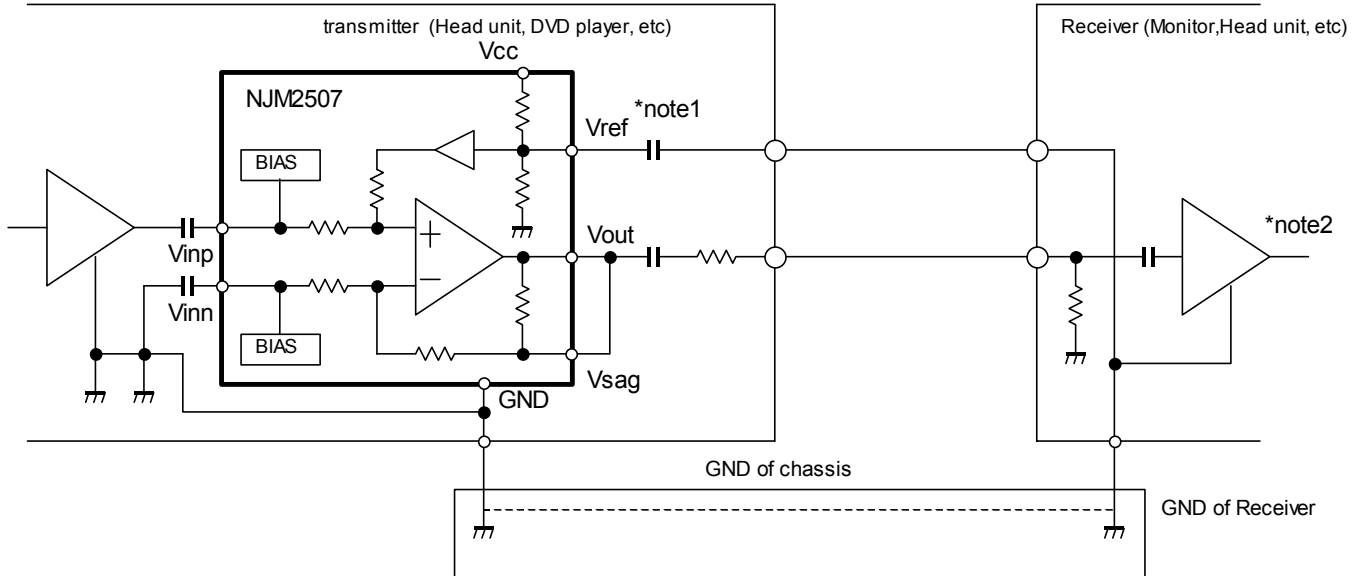

## ■ EQUIVALENT CIRCUIT(V<sub>CC</sub>=5V)

PIN No.	PIN NAME	EQUIVALENT CIRCUIT	DC VOLTAGE
1	V <sub>CC</sub>	-	-
2	Power Save		-
3 4	V <sub>INP</sub> V <sub>INN</sub>		2.5V
5	V <sub>REF</sub>		2.5V
6	GND	-	-
7	V <sub>SAG</sub>		2.5V
8	V <sub>OUT</sub>		2.5V

# NJM2507

## TYPICAL CHARACTERISTICS

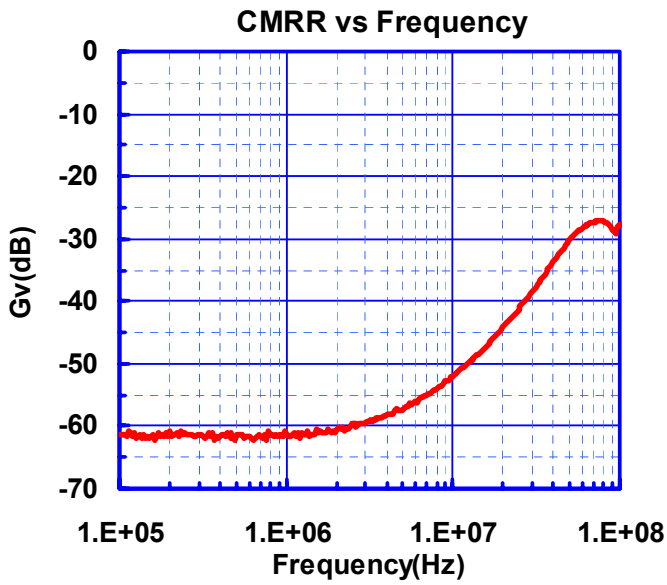
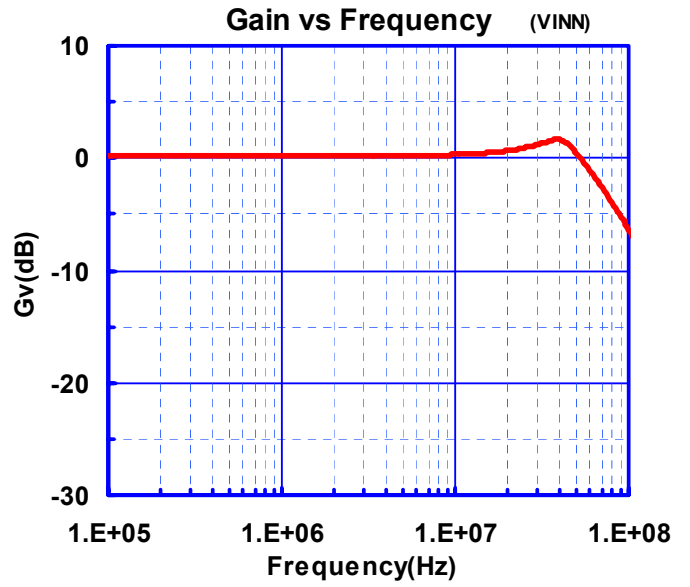
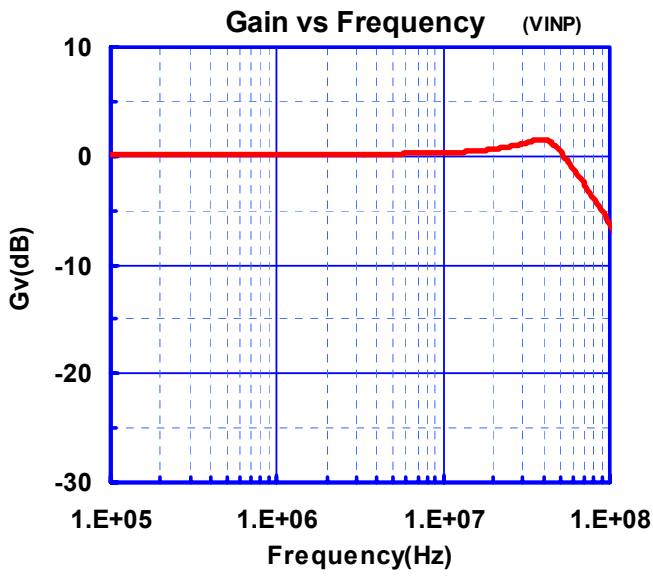

## TYPICAL CHARACTERISTICS

ICC vs Voltage

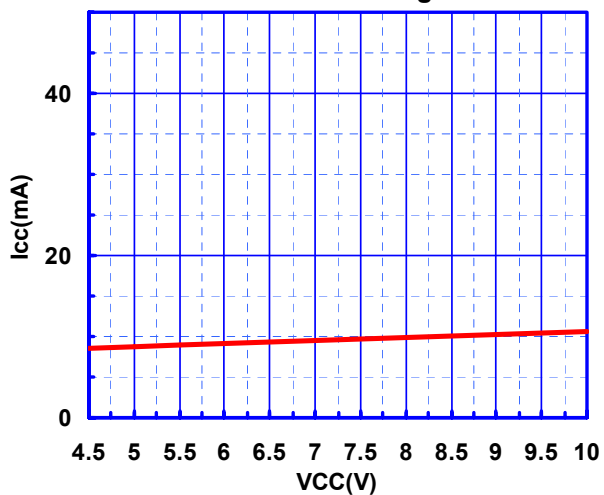

I<sub>save</sub> vs Voltage

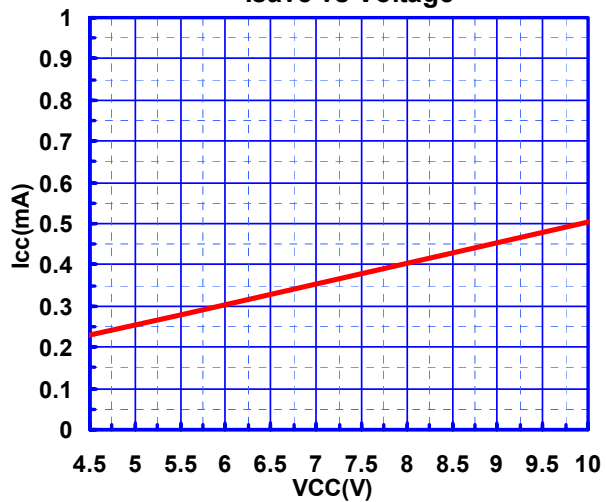

VOM vs Voltage (VINP)

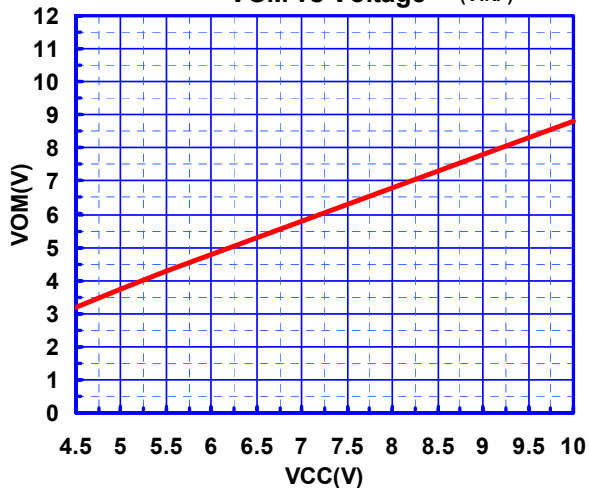

VOM vs Voltage (VINN)

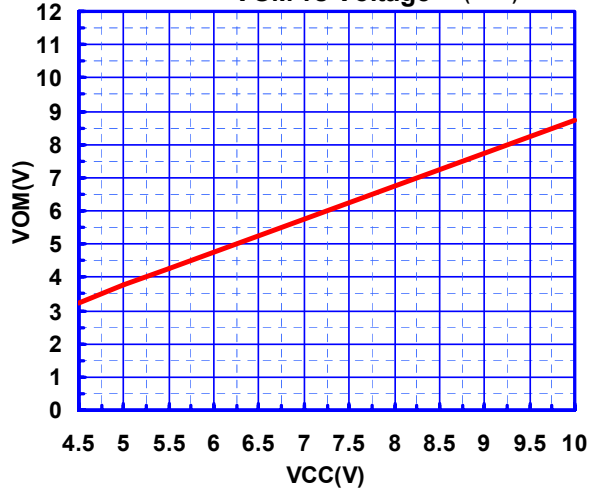

G<sub>v</sub> vs Voltage (VINP)

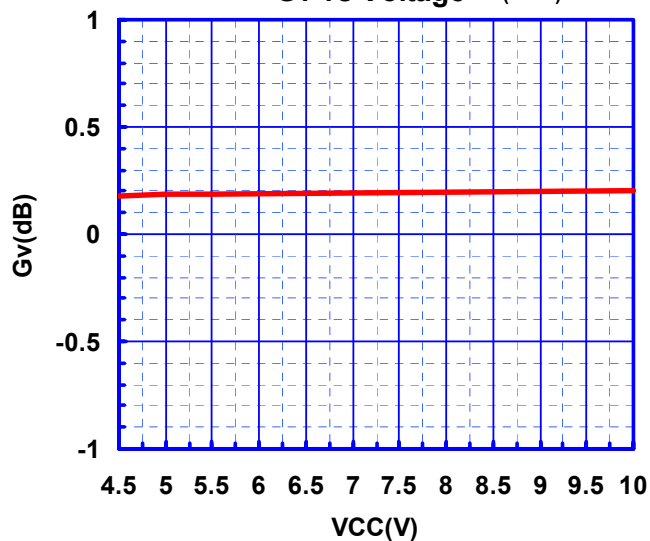

G<sub>v</sub> vs Voltage (VINN)

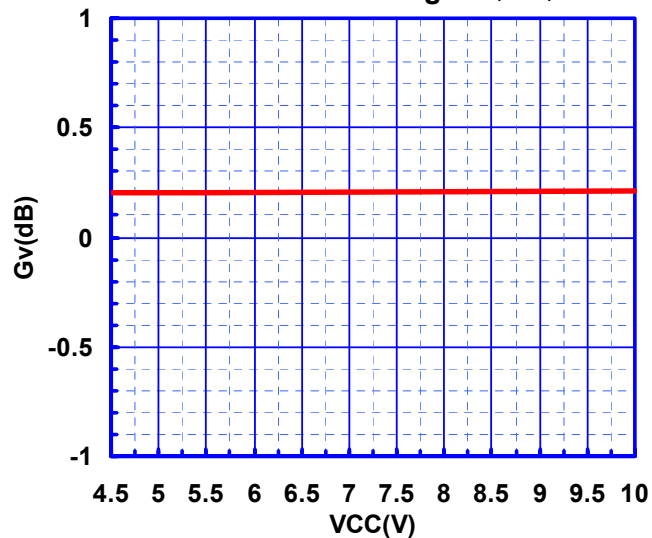

# NJM2507

## TYPICAL CHARACTERISTICS

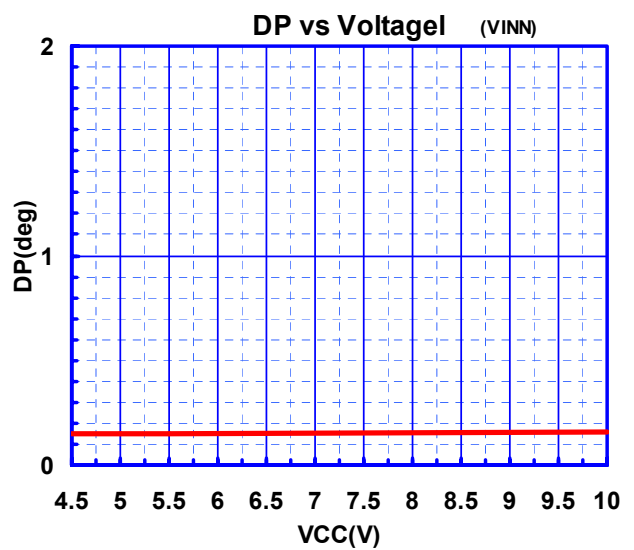
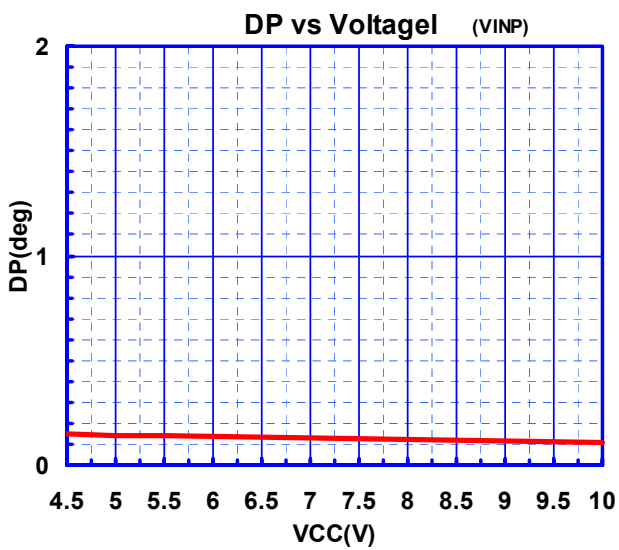
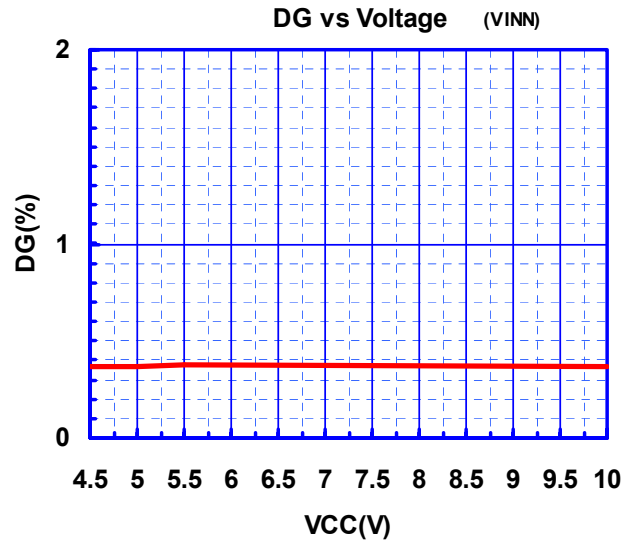
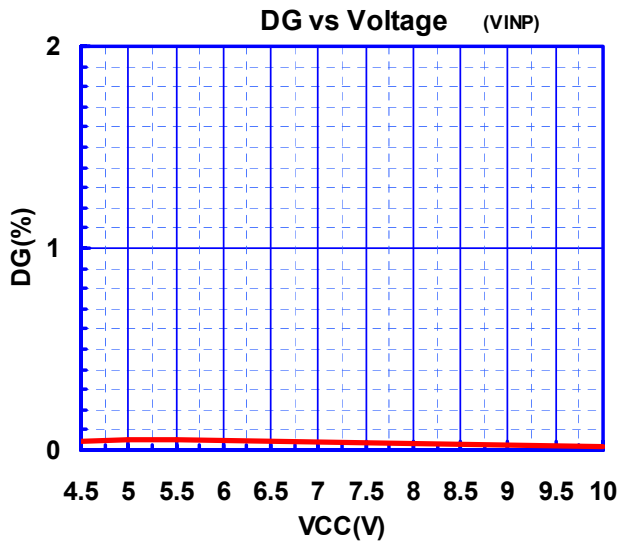
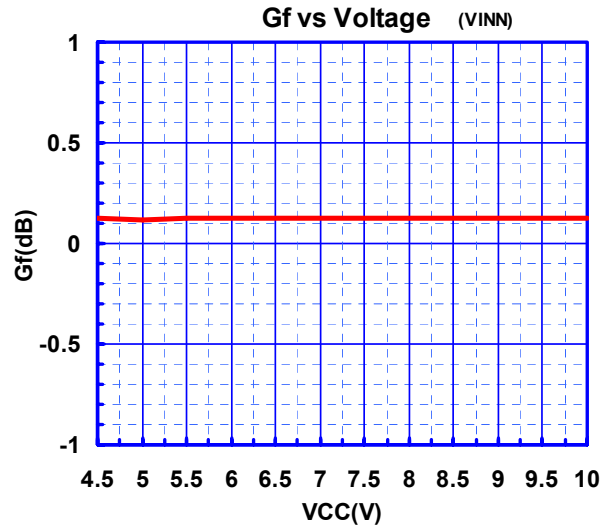
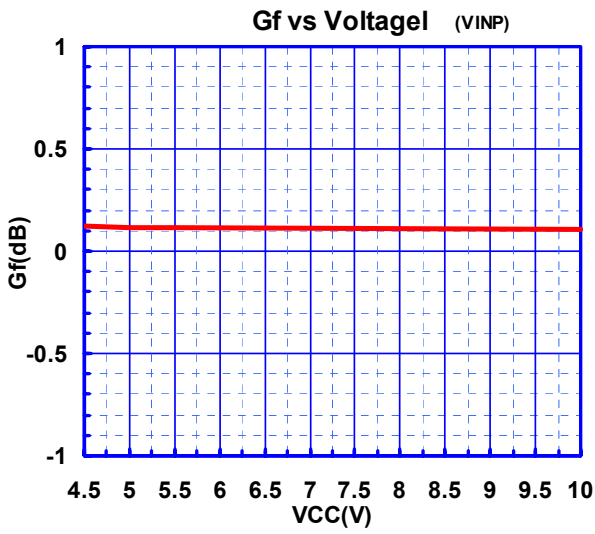



## TYPICAL CHARACTERISTICS

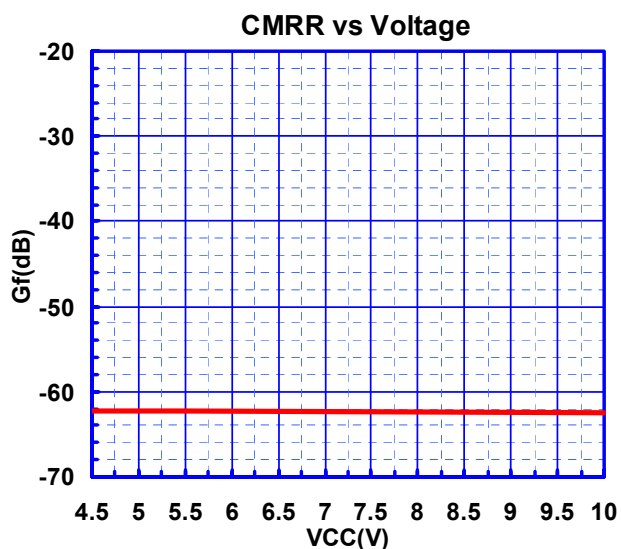
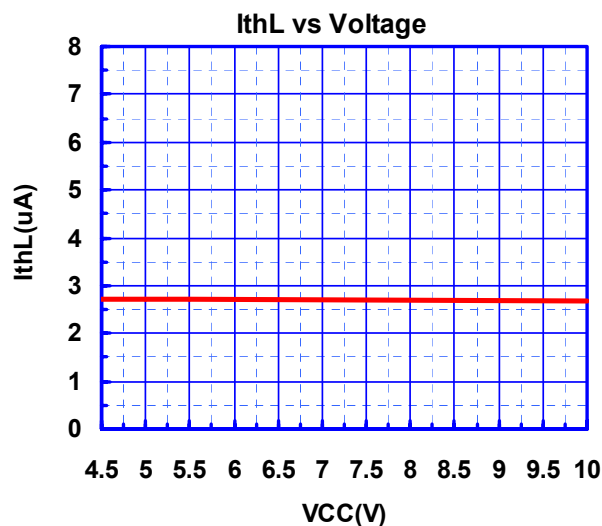
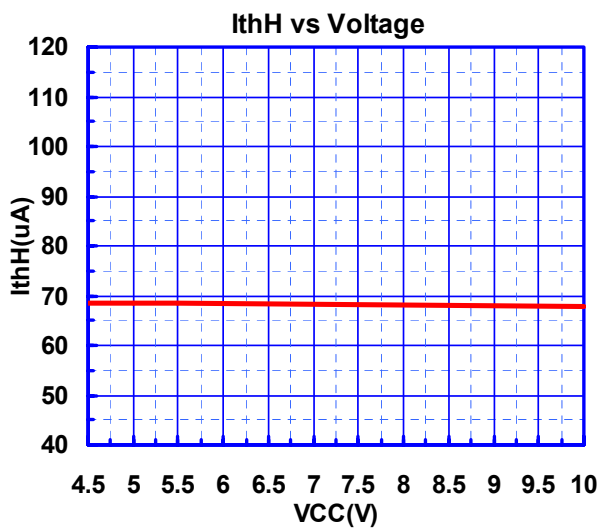
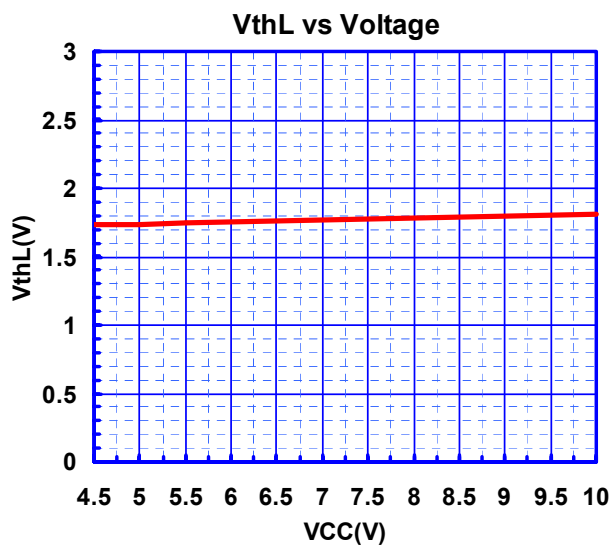
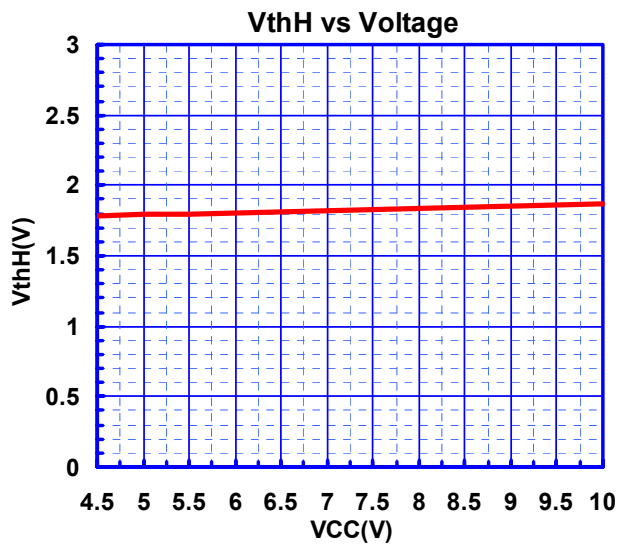

# NJM2507

## TYPICAL CHARACTERISTICS

ICC vs Temperature

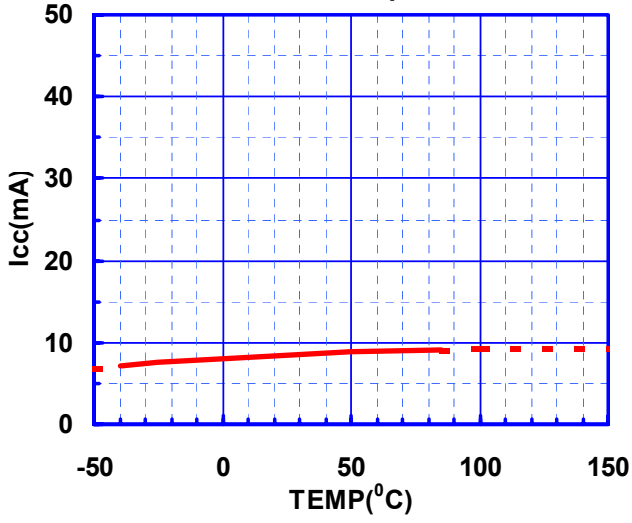

Isave vs Temperature

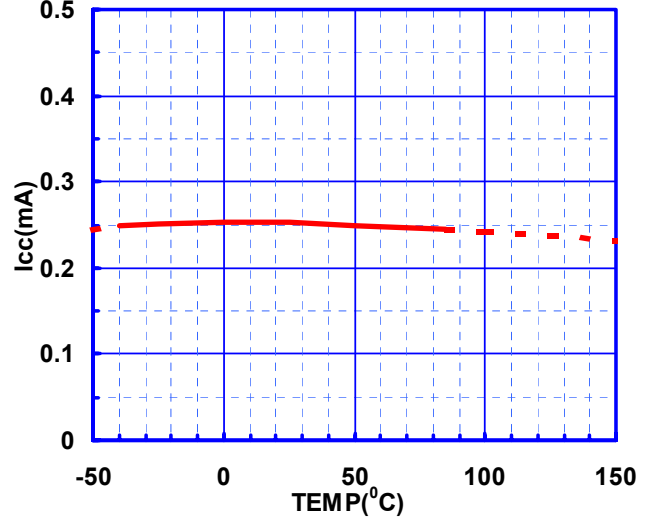

VOM vs Temperature (VINP)

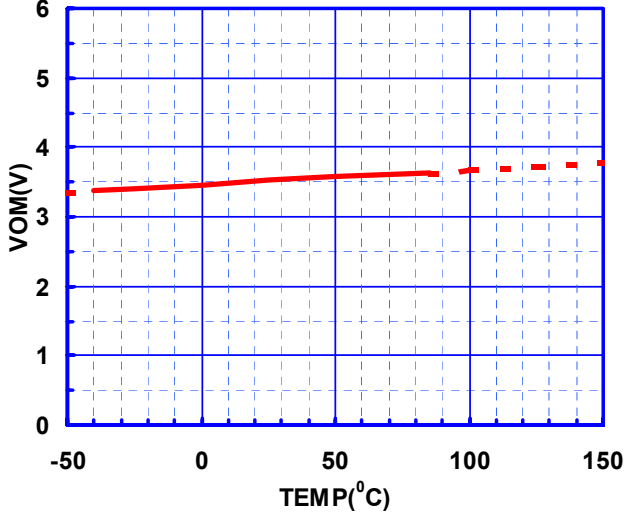

VOM vs Temperature (VINN)

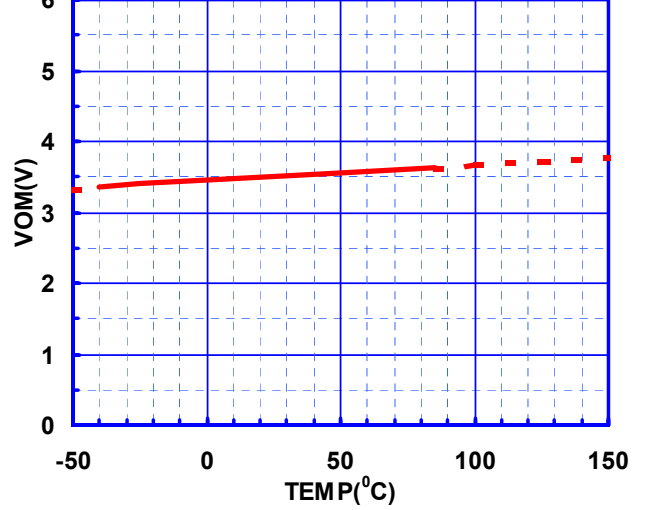

Gv vs Temperature (VINP)

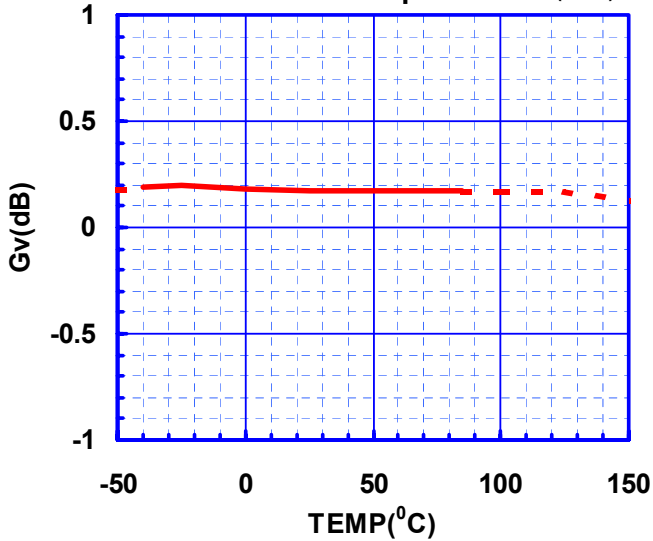

Gv vs Temperature (VINN)

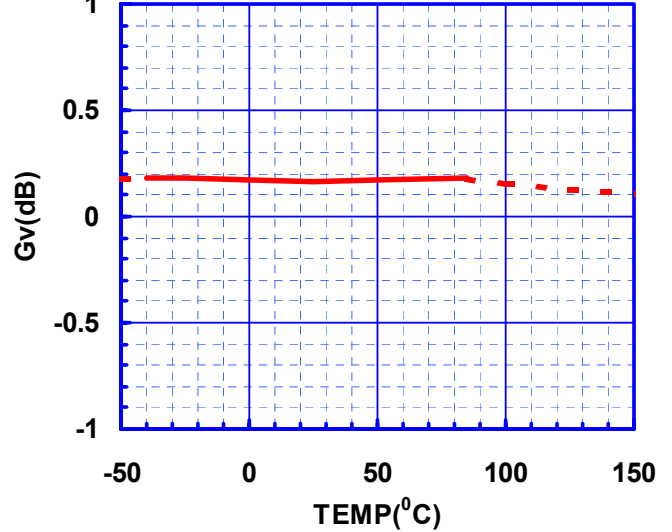

## TYPICAL CHARACTERISTICS

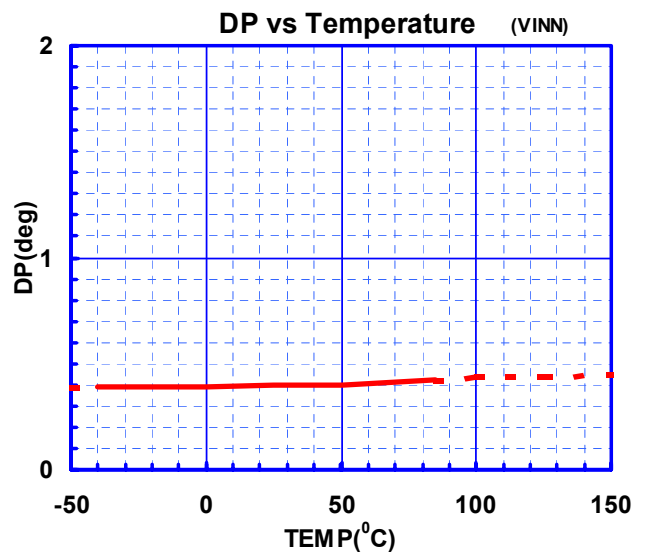
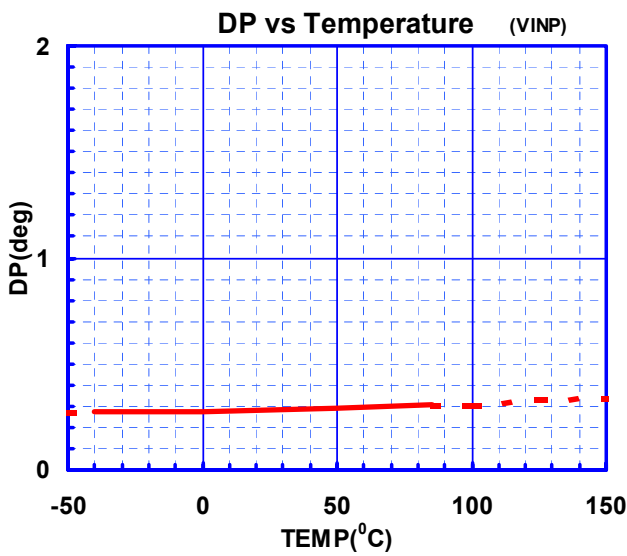
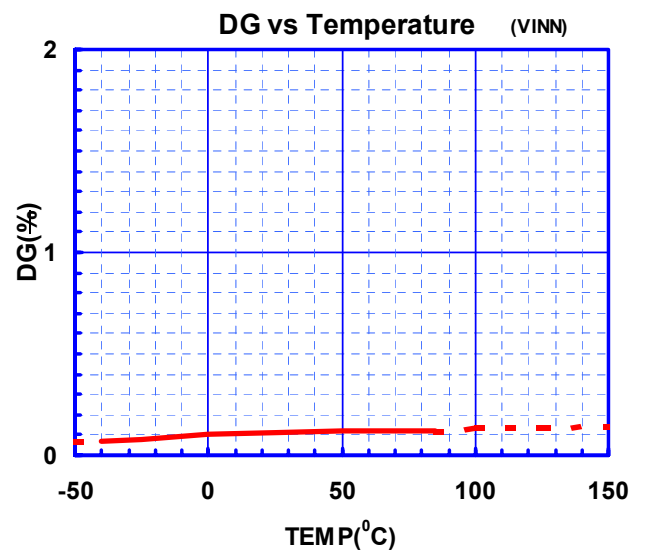
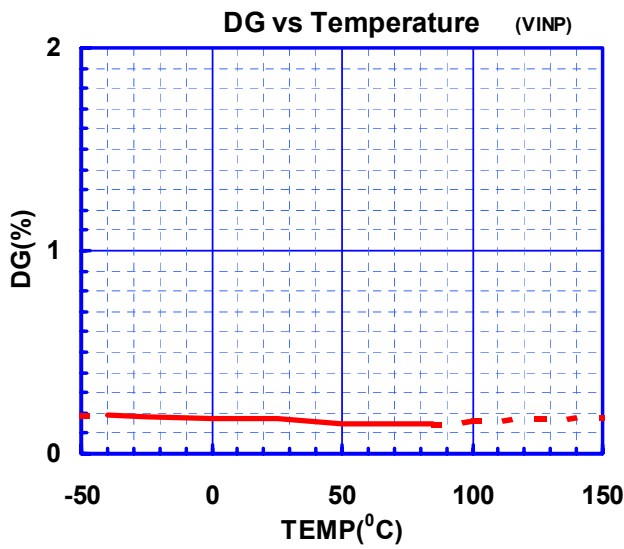
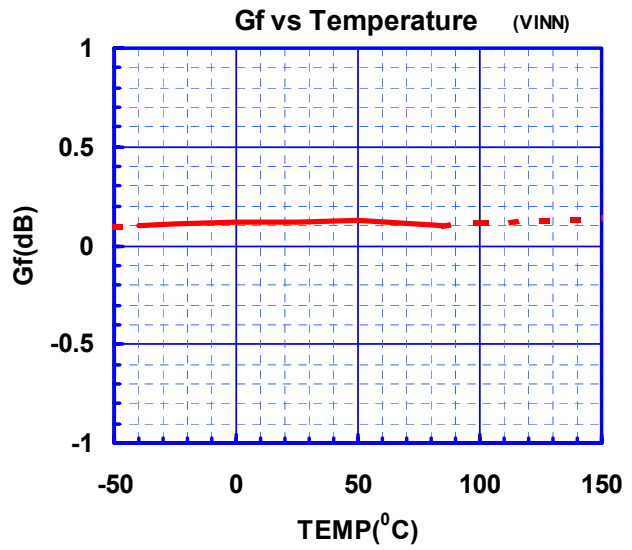
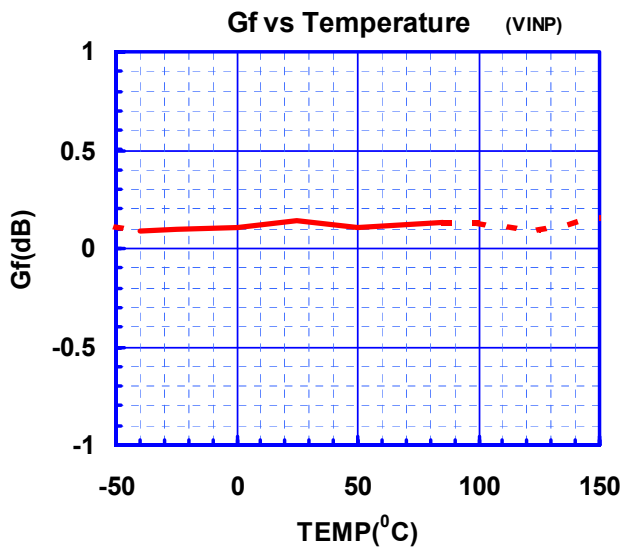

# NJM2507

## TYPICAL CHARACTERISTICS

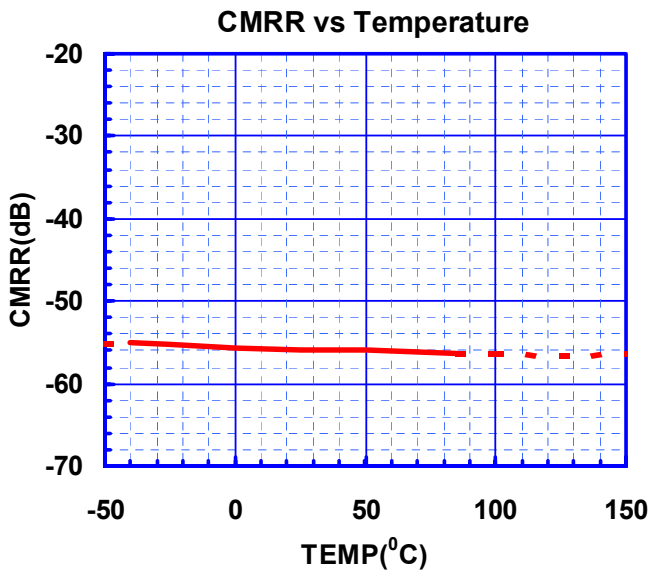
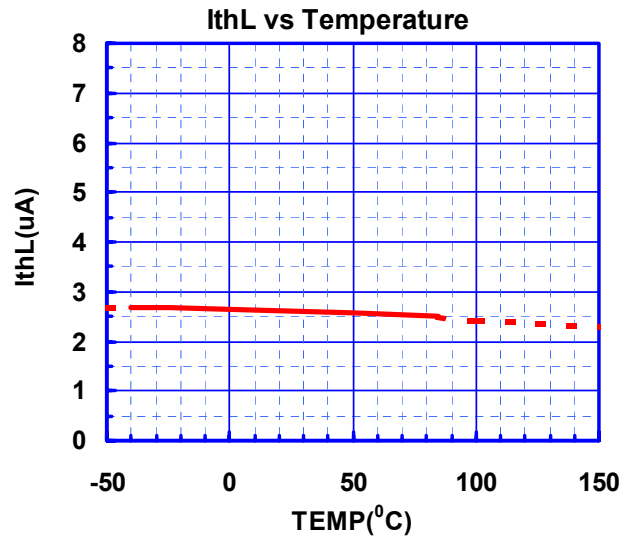
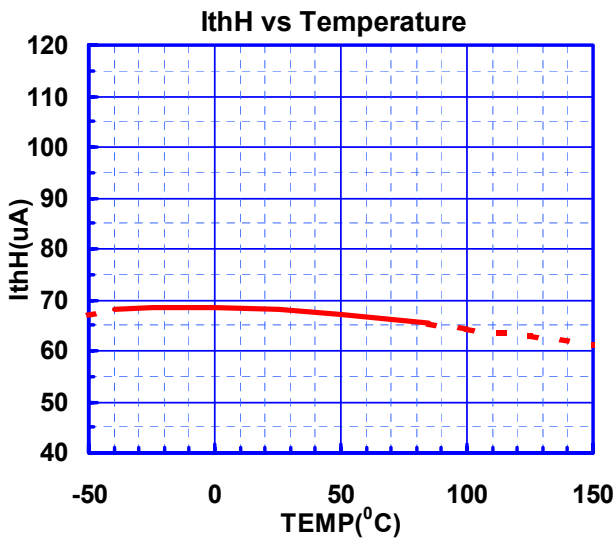
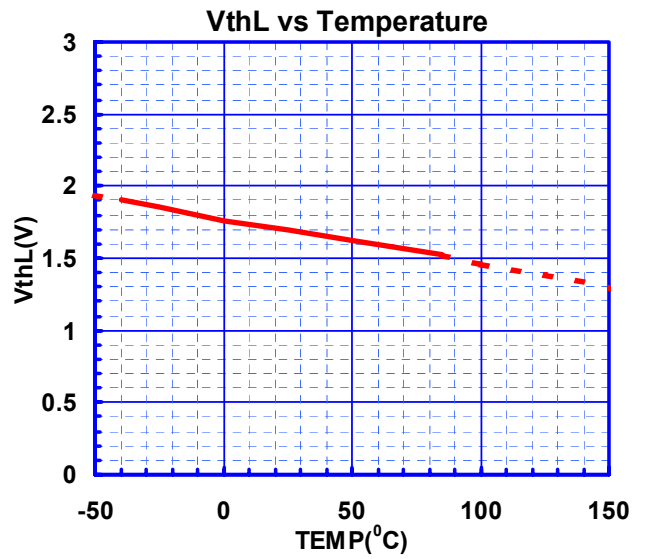
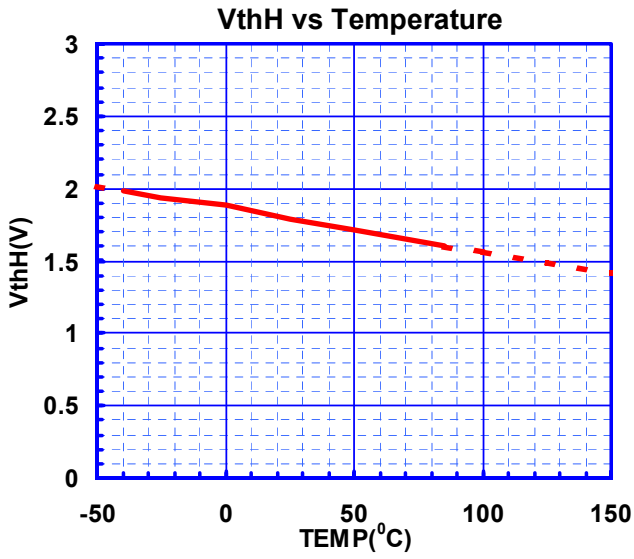

[CAUTION]  
 The specifications on this databook are only given for information, without any guarantee as regards either mistakes or omissions. The application circuits in this databook are described only to show representative usages of the product and not intended for the guarantee or permission of any right including the industrial rights.