

## SP5T SWITCH GaAs MMIC

### ■ GENERAL DESCRIPTION

The NJG1665MD7 is a GaAs SP5T switch featured low insertion loss, high isolation and small size package, and suited for mobile terminal applications. The NJG1665MD7 switches a path between common RF port and five RF ports by three bit control signal from 1.3V of logical high voltage. In addition, this switch includes ESD protection circuits for good ESD tolerance. The NJG1665MD7 is available in a very small, lead-free, halogen-free, 1.6mm x 1.6mm x 0.397 mm, 14-pin EQFN14-D7 package.

### ■ PACKAGE OUTLINE

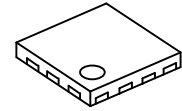

NJG1665MD7

### ■ APPLICATIONS

Multi-mode LTE, UMTS, CDMA and GSM applications  
 Receive system, RX path, and Diversity antenna applications  
 Mobile phone, Tablet PC, Data card, Modem and Router applications

### ■ FEATURES

- Low control voltage  $V_{CTL(H)} = +1.3V$  min
- Low operating voltage  $V_{DD} = +2.0 \sim +4.5V$
- Low insertion loss 0.40 dB typ. @f=1.0GHz,  $P_{IN}=23dBm$
- 0.50 dB typ. @f=2.0GHz,  $P_{IN}=23dBm$
- 0.60 dB typ. @f=2.5GHz,  $P_{IN}=23dBm$
- High ESD tolerance On-chip ESD protection circuit
- Small and thin package EQFN14-D7 (package size: 1.6mm x 1.6mm x 0.397mm typ.)
- Lead -free and halogen-free

### ■ PIN CONFIGURATION

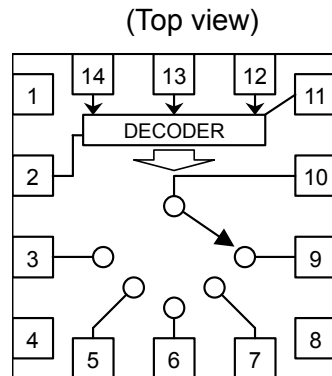

#### Pin connection

- |        |          |
|--------|----------|
| 1. GND | 8. GND   |
| 2. VDD | 9. P1    |
| 3. P5  | 10. PC   |
| 4. GND | 11. GND  |
| 5. P4  | 12. CTL3 |
| 6. P3  | 13. CTL2 |
| 7. P2  | 14. CTL1 |

### ■ TRUTH TABLE

PATH	CTL1	CTL2	CTL3
PC-P1	L	H	L
PC-P2	H	H	L
PC-P3	L	H	H
PC-P4	H	H	H
PC-P5	X	L	L

"H"... $V_{CTL(H)}$ , "L"... $V_{CTL(L)}$ , "X" ...Do not care.

**NOTE:** The information on this datasheet is subject to change without notice

# NJG1665MD7

## ■ ABSOLUTE MAXIMUM RATINGS

( $T_a=+25^{\circ}\text{C}$ ,  $Z_s=Z_l=50\Omega$ )

PARAMETER	SYMBOL	CONDITIONS	RATINGS	UNITS
RF input power	$P_{IN}$	$V_{DD}=2.7\text{V}$ , $V_{CTL}=0\text{V} / 1.8\text{V}$	30	dBm
Supply voltage	$V_{DD}$	VDD terminal	5.0	V
Control voltage	$V_{CTL}$	CTL1~3 terminals	5.0	V
Power dissipation	$P_D$	Four-layer FR4 PCB with through-hole (74.2mmx74.2mm), $T_j=150^{\circ}\text{C}$	1300	mW
Operating temp.	$T_{opr}$		-40~+85	$^{\circ}\text{C}$
Storage temp.	$T_{stg}$		-55~+150	$^{\circ}\text{C}$

## ■ ELECTRICAL CHARACTERISTICS (DC)

(General conditions:  $V_{DD}=2.7\text{V}$ ,  $V_{CTL(L)}=0\text{V}$ ,  $V_{CTL(H)}=1.8\text{V}$ ,  $Z_s=Z_l=50\Omega$ ,  $T_a=+25^{\circ}\text{C}$ , with application circuit)

PARAMETERS	SYMBOL	CONDITIONS	MIN	TYP	MAX	UNITS
Supply voltage	$V_{DD}$		2.0	2.7	4.5	V
Operating current	$I_{DD}$	$f=2.0\text{GHz}$ , $P_{IN}=23\text{dBm}$		45	100	$\mu\text{A}$
Control voltage (LOW)	$V_{CTL(L)}$		0	-	0.4	V
Control voltage (HIGH)	$V_{CTL(H)}$		1.3	1.8	4.5	V
Control Current	$I_{CTL}$		-	5	10	$\mu\text{A}$

## ■ ELECTRICAL CHARACTERISTICS (RF)

(General conditions:  $V_{DD}=2.7\text{V}$ ,  $V_{CTL(L)}=0\text{V}$ ,  $V_{CTL(H)}=1.8\text{V}$ ,  $Z_s=Z_l=50\Omega$ ,  $T_a=+25^{\circ}\text{C}$ , with application circuit)

PARAMETERS	SYMBOL	CONDITIONS	MIN	TYP	MAX	UNITS
Insertion Loss1	LOSS1	$f=1.0\text{GHz}$ , $P_{IN}=23\text{dBm}$	-	0.40	0.60	dB
Insertion Loss2	LOSS2	$f=2.0\text{GHz}$ , $P_{IN}=23\text{dBm}$	-	0.50	0.70	dB
Insertion Loss3	LOSS3	$f=2.5\text{GHz}$ , $P_{IN}=23\text{dBm}$	-	0.60	0.80	dB
Isolation1	ISL1	$f=1.0\text{GHz}$ , $P_{IN}=23\text{dBm}$	25	29	-	dB
Isolation2	ISL2	$f=2.0\text{GHz}$ , $P_{IN}=23\text{dBm}$	20	23	-	dB
Isolation3	ISL3	$f=2.5\text{GHz}$ , $P_{IN}=23\text{dBm}$	18	21	-	dB
Input Power at 0.2dB Compression Point	$P_{-0.2\text{dB}}$	$f=2.0\text{GHz}$	26	29	-	dBm
VSWR	VSWR	$f=2.0\text{GHz}$ , ON state		1.2	1.5	
Switching Time	$T_{SW}$	50% CTL to 10%/90% RF		1	5	$\mu\text{s}$

## ■ TERMINAL INFORMATION

No.	SYMBOL	DESCRIPTION
1	GND	Ground terminal. Connect to the PCB ground plane.
2	VDD	Power supply input. This terminal should be connected to GND via a bypass capacitor.
3	P5	RF input / output port. External capacitor is required to block the DC bias voltage of internal circuit.
4	GND	Ground terminal. Connect to the PCB ground plane.
5	P4	RF input / output port. External capacitor is required to block the DC bias voltage of internal circuit.
6	P3	RF input / output port. External capacitor is required to block the DC bias voltage of internal circuit.
7	P2	RF input / output port. External capacitor is required to block the DC bias voltage of internal circuit.
8	GND	Ground terminal. Connect to the PCB ground plane.
9	P1	RF input / output port. External capacitor is required to block the DC bias voltage of internal circuit.
10	PC	Common RF input / output port. External capacitor is required to block the DC bias voltage of internal circuit.
11	GND	Ground terminal. Connect to the PCB ground plane.
12	CTL3	Control port. "High level" is DC +1.3V~4.5V, "Low level" is DC 0~+0.4V.
13	CTL2	Control port. "High level" is DC +1.3V~4.5V, "Low level" is DC 0~+0.4V.
14	CTL1	Control port. "High level" is DC +1.3V~4.5V, "Low level" is DC 0~+0.4V.

# NJG1665MD7

## ■ ELECTRICAL CHARACTERISTICS (With Application circuit, Loss of external circuit are excluded)

### Loss, ISL vs Frequency

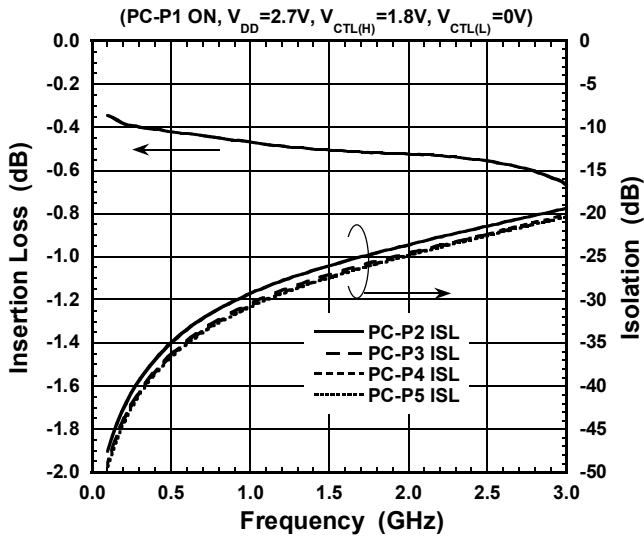

### Loss, VSWR vs Frequency

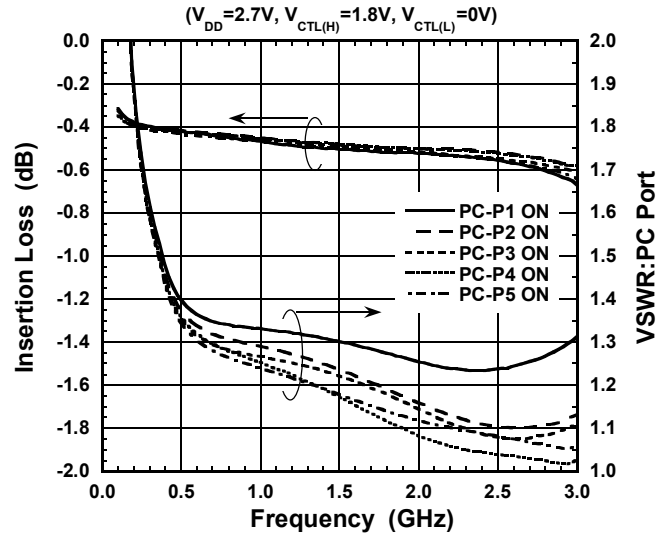

### Output Power, $I_{DD}$ vs Input Power

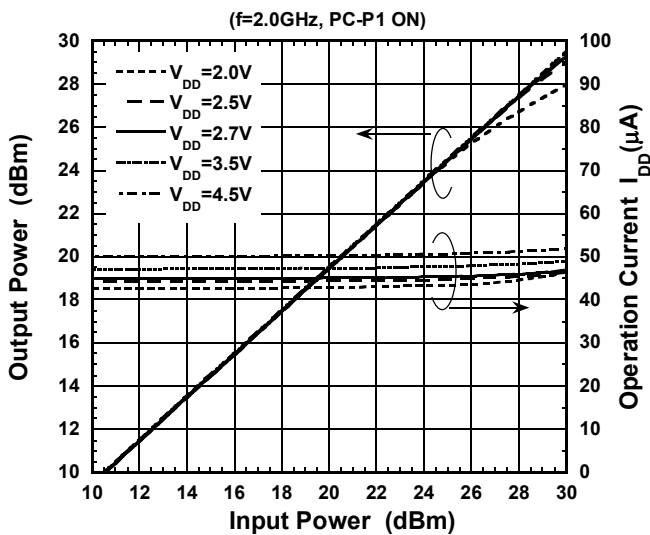

### Loss, ISL vs Input Power

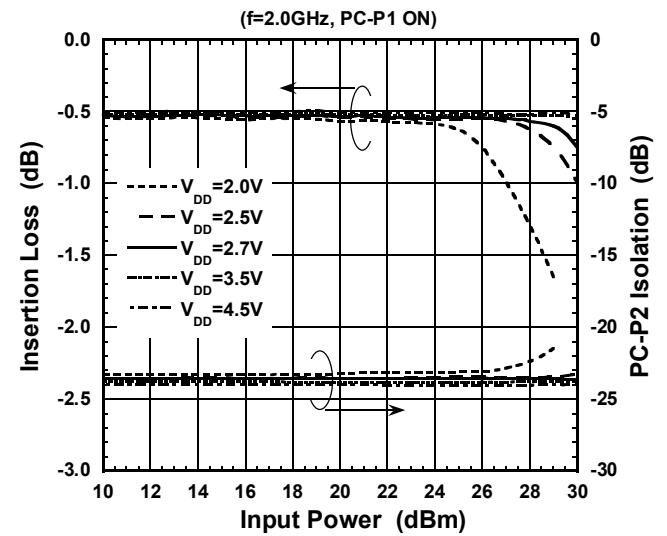

### Switching Time

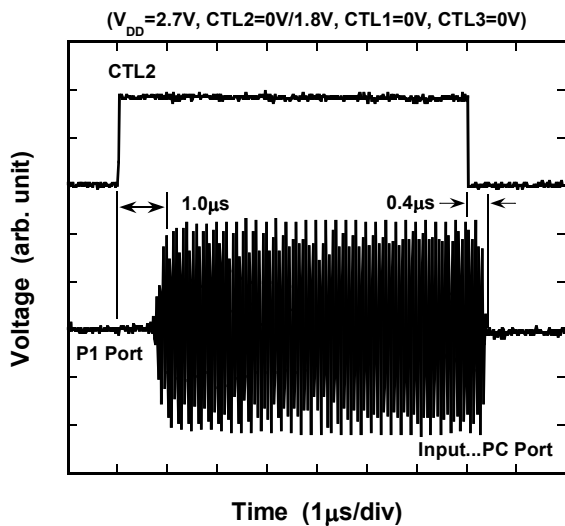

**ELECTRICAL CHARACTERISTICS** (With Application circuit, Loss of external circuit are excluded)

**Operation Current vs Temperature**

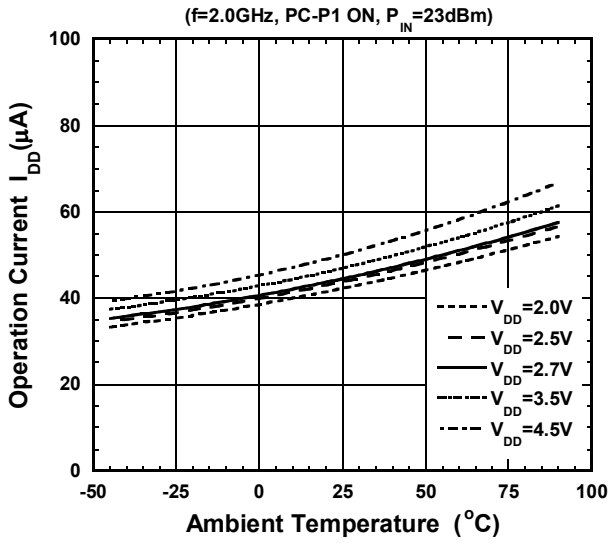

**Control Current vs Temperature**

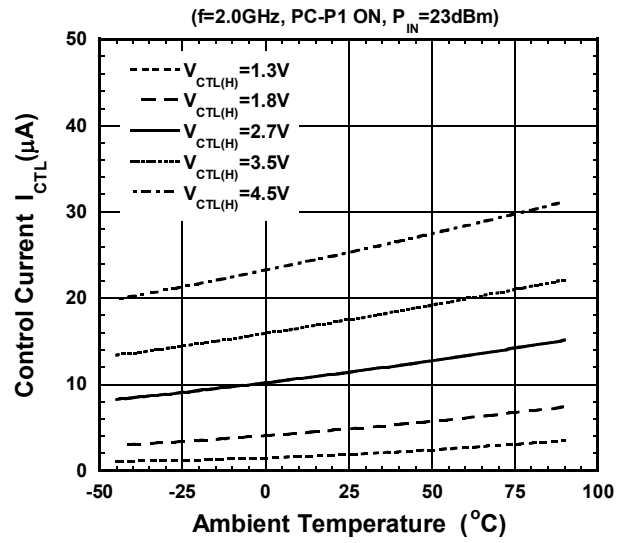

**LOSS, ISL vs Temperature**

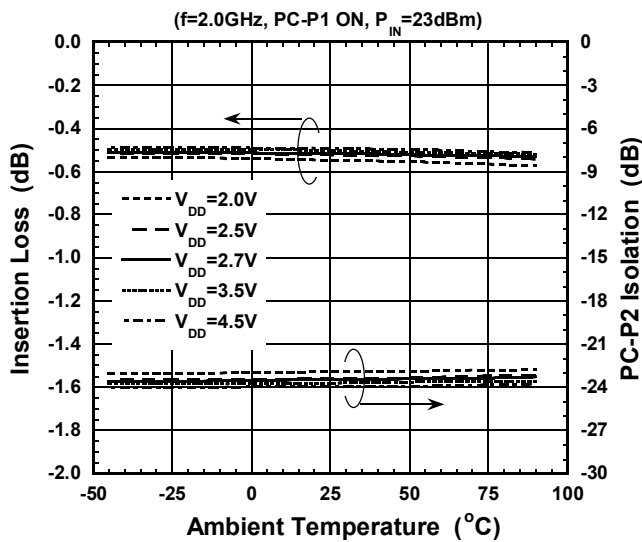

**VSWR vs Temperature**

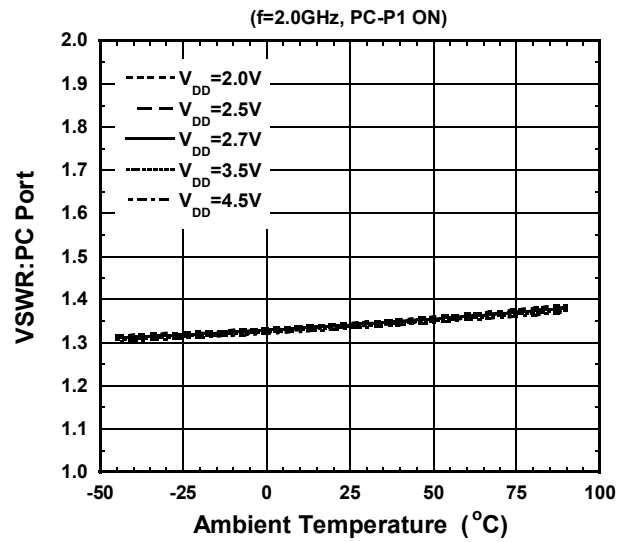

**P<sub>-0.2dB</sub> vs Temperature**

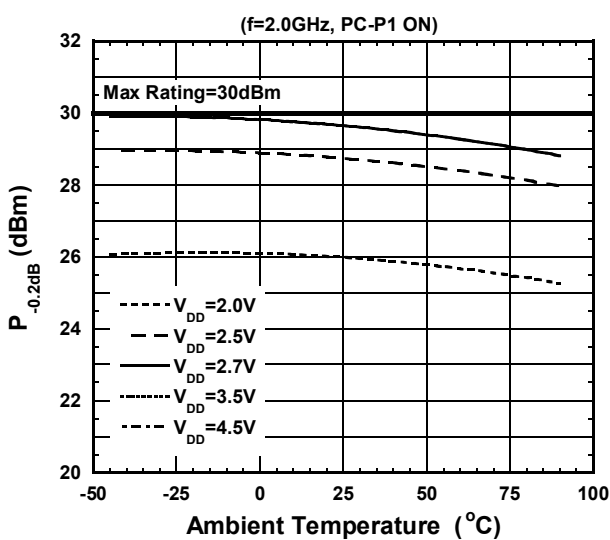

**Switching Time vs Temperature**

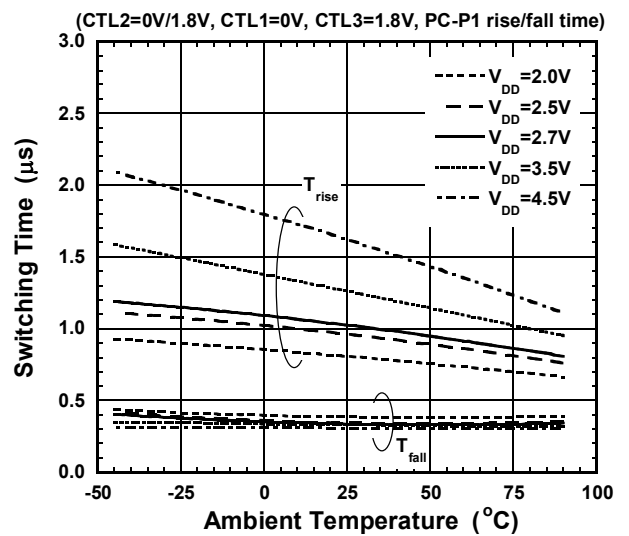

# NJG1665MD7

## APPLICATION CIRCUIT

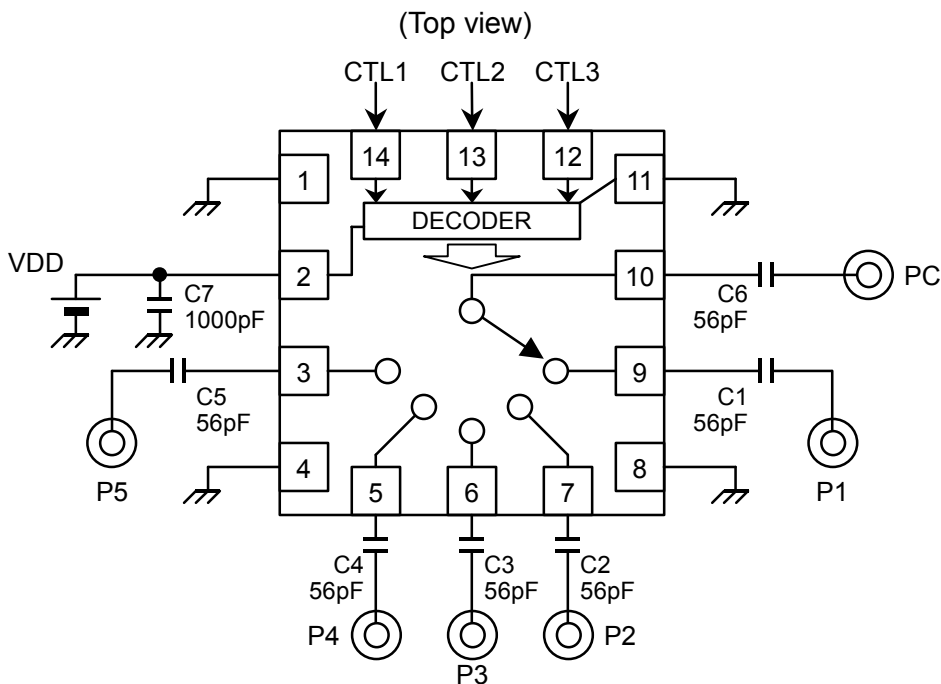

### PARTS LIST

Part ID	Value	Notes
C1~C6	56pF	MURATA MFG (GRM15)
C7	1000pF	

## TEST PCB LAYOUT

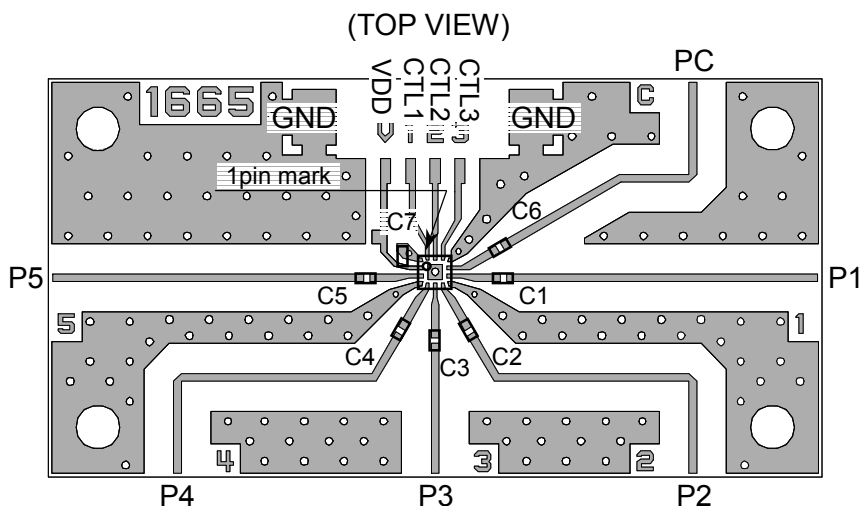

PCB SIZE=39.0 x 20.0mm  
 PCB: FR-4, t=0.2mm  
 CAPACITOR: size 1005  
 STRIP LINE WIDTH=0.4mm

### Losses of PCB and Connectors

Freq. (GHz)	Loss (dB)		
	PC-P1 PC-P5	PC-P2 PC-P4	PC-P3
1.0	0.41	0.43	0.36
2.0	0.62	0.65	0.52
2.5	0.74	0.79	0.61

## PRECAUTIONS

- [1] The DC blocking capacitors should be placed at RF terminal of P1, P2, P3, P4, P5 and PC. Please choose appropriate capacitance values to the application frequency.
- [2] The bypass capacitor (C7) should be placed as close as possible to VDD terminal.
- [3] For good RF performance, all GND terminals are should be connected to PCB ground plane.

## PACKAGE OUTLINE (EQFN14-D7)

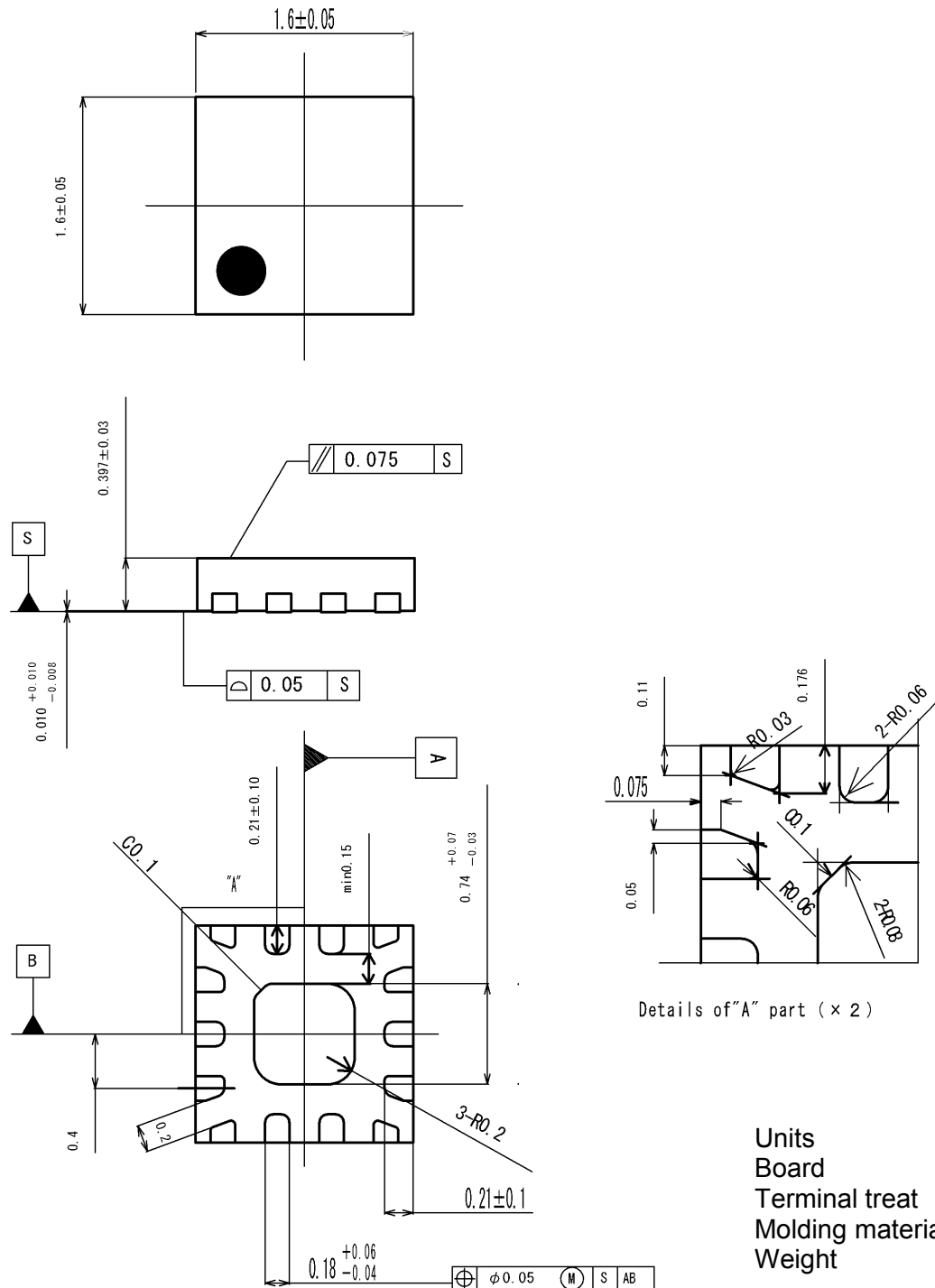

### Cautions on using this product

This product contains Gallium-Arsenide (GaAs) which is a harmful material.

- Do NOT eat or put into mouth.
- Do NOT dispose in fire or break up this product.
- Do NOT chemically make gas or powder with this product.
- To waste this product, please obey the relating law of your country.

### [CAUTION]

The specifications on this databook are only given for information, without any guarantee as regards either mistakes or omissions. The application circuits in this databook are described only to show representative usages of the product and not intended for the guarantee or permission of any right including the industrial rights.

This product may be damaged with electric static discharge (ESD) or spike voltage. Please handle with care to avoid these damages.