

WIDE BAND LOW NOISE AMPLIFIER GaAs MMIC

■ GENERAL DESCRIPTION

The NJG1146KG1 is a fully matched wide band low noise amplifier GaAs MMIC for terrestrial application.

To achieve wide dynamic range, the NJG1146KG1 offers high gain mode and low gain mode. Selecting high gain mode for weak signals, the NJG1146KG1 helps improve receiver sensitivity through high gain and low noise figure. Selecting low gain mode for strong signals, it bypasses LNA circuit to offer higher linearity.

An small and ultra-thin package of ESON6-G1 is adopted.

■ PACKAGE OUTLINE



NJG1146KG1

■ APPLICATIONS

Terrestrial application from 40MHz to 900MHz
Digital TV, Set-top box and Broadband CATV applications

■ FEATURES

- Operating frequency 40MHz~900MHz
- Operating voltage 5.0V typ.
- Package size ESON6-G1 (Package size: 1.6mm x 1.6mm x 0.397mm typ.)

[High gain mode]

- Operating current 60mA typ.
- Gain 12.0dB typ.
- Noise figure 2.2dB typ.
- IM2 52.0dB typ.
- IM3 80.0dB typ.

[Low gain mode]

- Low current consumption 30μA typ.
- Gain(Low loss) -1.0dB typ.

■ PIN CONFIGURATION

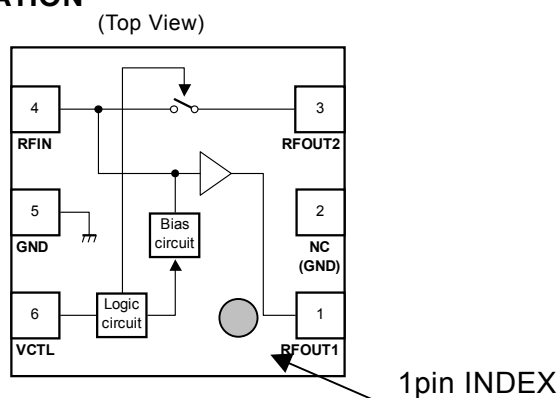

Pin Connection

1. RFOUT1
 2. NC(GND)
 3. RFOUT2
 4. RFIN
 5. GND
 6. VCTL
- *Exposed PAD: GND

■ TRUTH TABLE "H"=V_{CTL(H)} "L"=V_{CTL(L)}

| V _{CTL} | LNA ON | Bypass | LNA mode |
|------------------|--------|--------|----------------|
| H | ON | OFF | High Gain mode |
| L | OFF | ON | Low Gain mode |

Note: Specifications and description listed in this datasheet are subject to change without notice.

NJG1146KG1

■ ABSOLUTE MAXIMUM RATINGS

$T_a=+25^{\circ}\text{C}$, $Z_s=Z_i=50\ \text{ohm}$

| PARAMETER | SYMBOL | CONDITIONS | RATINGS | UNITS |
|-----------------------|-----------|--|----------|--------------------|
| Drain voltage | V_{DD} | | 6.0 | V |
| Control voltage | V_{CTL} | | 6.0 | V |
| Input power | P_{IN} | $V_{DD}=5.0\text{V}$ | +10 | dBm |
| Power dissipation | P_D | 4-layer FR4 PCB with through-hole (101.5x114.5mm), $T_j=150^{\circ}\text{C}$ | 1200 | mW |
| Operating temperature | T_{opr} | | -40~+85 | $^{\circ}\text{C}$ |
| Storage temperature | T_{stg} | | -55~+150 | $^{\circ}\text{C}$ |

■ ELECTRICAL CHARACTERISTICS1 (DC CHARACTERISTICS)

$V_{DD}=5.0\text{V}$, $T_a=+25^{\circ}\text{C}$, with application circuit

| PARAMETERS | SYMBOL | CONDITIONS | MIN | TYP | MAX | UNITS |
|------------------------|--------------|-------------------------------|-----|-----|-----|---------------|
| Operating voltage | V_{DD} | | 2.4 | 5.0 | 5.5 | V |
| Control voltage (High) | $V_{CTL(H)}$ | | 1.3 | 1.8 | 5.5 | V |
| Control voltage (Low) | $V_{CTL(L)}$ | | 0.0 | 0.0 | 0.5 | V |
| Operating current1 | I_{DD1} | RF OFF, $V_{CTL}=1.8\text{V}$ | - | 60 | 80 | mA |
| Operating current2 | I_{DD2} | RF OFF, $V_{CTL}=0\text{V}$ | - | 30 | 50 | μA |
| Control current | I_{CTL} | RF OFF, $V_{CTL}=1.8\text{V}$ | - | 6 | 12 | μA |

■ ELECTRICAL CHARACTERISTICS2 (High Gain mode)

$V_{DD}=5.0V$, $V_{CTL}=1.8V$, freq=40~900MHz, $T_a=+25^{\circ}C$, $Z_S=Z_I=50\text{ ohm}$, with application circuit

| PARAMETERS | SYMBOL | CONDITIONS | MIN | TYP | MAX | UNITS |
|--|------------|--|-------|-------|-------|-------|
| Small signal gain1 | Gain1 | Exclude PCB & connector losses *1 | 9.0 | 12.0 | 14.0 | dB |
| Noise figure1_1 | NF1_1 | freq=40~80MHz, Exclude PCB & connector losses *2 | - | 2.5 | 4.0 | dB |
| Noise figure1_2 | NF1_2 | freq=80~900MHz, Exclude PCB & connector losses *2 | - | 2.2 | 3.0 | dB |
| Input power at 1dB gain compression point1 | P-1dB(IN)1 | | +0.0 | +6.0 | - | dBm |
| Input 3rd order intercept point1 | IIP3_1 | f1=freq, f2=freq+100kHz, $P_{IN}=-12\text{dBm}$ | +16.0 | +22.0 | - | dBm |
| 2nd order intermodulation distortion1 | IM2_1 | f1=200MHz, f2=500MHz, fmeas=700MHz, $P_{IN1}=P_{IN2}=-15\text{dBm}$ *3 | 42.0 | 52.0 | - | dB |
| 3rd order intermodulation distortion1 | IM3_1 | f1=600MHz, f2=650MHz, fmeas=700MHz, $P_{IN1}=P_{IN2}=-15\text{dBm}$ *3 | 55.0 | 80.0 | - | dB |
| Isolation | ISL1 | S12 | - | -17.0 | -13.0 | dB |
| RF IN Return loss1 | RLi1 | | 7.0 | 10.0 | - | dB |
| RF OUT Return loss1 | RLo1 | | 7.0 | 10.0 | - | dB |

*1 Input & output PCB and connector losses: 0.014dB(40MHz), 0.088dB(620MHz), 0.121dB(900MHz)

*2 Input PCB and connector losses: 0.007dB(40MHz), 0.011dB(80MHz), 0.044dB(620MHz), 0.060dB(900MHz)

*3 Definitions of IM2 and IM3.

Pout(dBm)

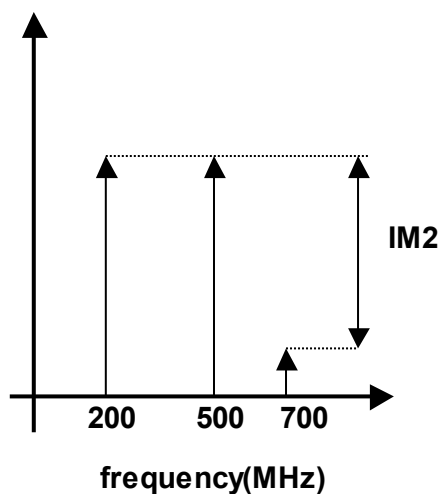

Pout(dBm)

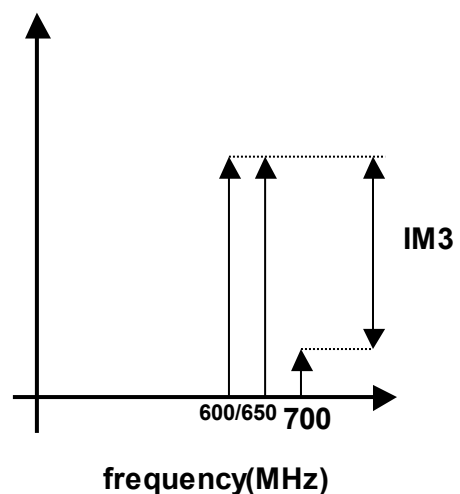

NJG1146KG1

■ ELECTRICAL CHARACTERISTICS3 (High Gain mode)

$V_{DD}=5.0V$, $V_{CTL}=1.8V$, freq=40~900MHz, $T_a=+25^{\circ}C$, $Z_S=Z_L=75\text{ ohm}$, with application circuit

| PARAMETERS | SYMBOL | CONDITIONS | MIN | TYP | MAX | UNITS |
|------------------------|--------|---|-----|------|-----|-------|
| Small signal gain75 | Gain75 | Exclude PCB & connector losses *1 | - | 12.0 | - | dB |
| Composite Second Order | CSO | 74channels *4, CW $P_{IN}=+15dBmV$ fmeas=295.25MHz, | - | -56 | - | dBc |
| Composite Triple Beat | CTB | 74channels *4, CW $P_{IN}=+15dBmV$ fmeas=295.25±1.25MHz, | - | -81 | - | dBc |
| Cross Modulation | XMOD | 74channels *4, Modulation $P_{IN}=+15dBmV$ fmeas=295.25±15.75kHz, | - | -80 | - | dBc |
| RF IN Return loss75 | RLi75 | | - | 15 | - | dB |
| RF OUT Return loss75 | RLo75 | | - | 15 | - | dB |

*1 Input & output PCB and connector losses: 0.014dB(40MHz), 0.088dB(620MHz), 0.121dB(900MHz)

*4 74channels: ch1~C63(91.25~463.25MHz 6MHz step) and U13~U25(471.25~543.25MHz 6MHz step) except ch7(189.25MHz), C28(253.25MHz)

■ ELECTRICAL CHARACTERISTICS4 (Low Gain mode)

$V_{DD}=5.0V$, $V_{CTL}=0V$, $freq=40\sim 900MHz$, $T_a=+25^{\circ}C$, $Z_S=Z_L=50\text{ ohm}$, with application circuit

| PARAMETERS | SYMBOL | CONDITIONS | MIN | TYP | MAX | UNITS |
|--|------------------------|---|-------|-------|-----|-------|
| Small signal gain ² | Gain ₂ | Exclude PCB & connector losses *1 | -2.5 | -1.0 | - | dB |
| Input power at 1dB gain compression point ² | P-1dB(IN) ₂ | | +10.0 | +16.0 | - | dBm |
| Input 3rd order intercept point ² | IIP3_2 | f1=freq, f2=freq+100kHz, P _{IN} =-2dBm | +25.0 | +33.0 | - | dBm |
| 2nd order intermodulation distortion ¹ | IM2_2 | f1=200MHz, f2=500MHz, fmeas=700MHz, P _{IN1} =P _{IN2} =0dBm *3 | 40.0 | 60.0 | - | dB |
| 3rd order intermodulation distortion ¹ | IM3_2 | f1=600MHz, f2=650MHz, fmeas=700MHz, P _{IN1} =P _{IN2} =0dBm *3 | 48.0 | 70.0 | - | dB |
| RF IN Return loss ² | RLi ₂ | | 8.0 | 15.0 | - | dB |
| RF OUT Return loss ² | RLo ₂ | | 8.0 | 15.0 | - | dB |

*1 Input & output PCB and connector losses: 0.014dB(40MHz), 0.088dB(620MHz), 0.121dB(900MHz)

*3 Definitions of IM2 and IM3.

Pout(dBm)

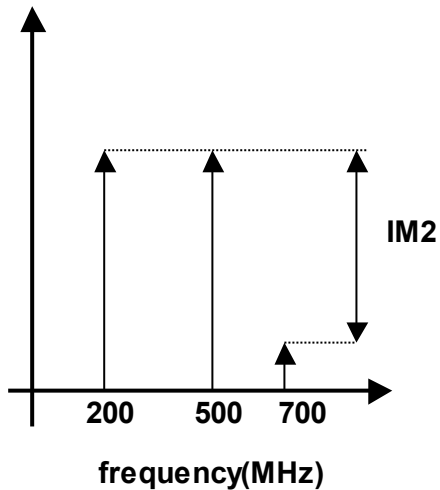

Pout(dBm)

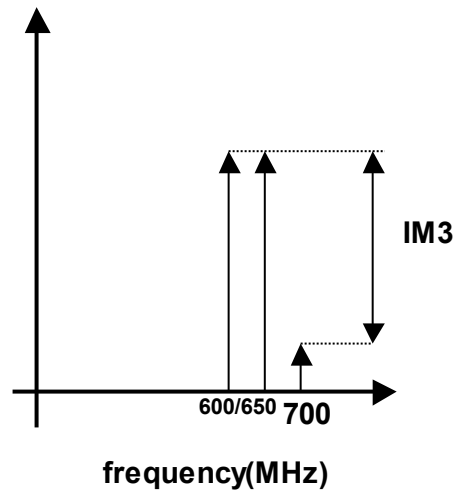

NJG1146KG1

■ TERMINAL INFORMATION

| No. | SYMBOL | DESCRIPTION |
|-------------|---------|---|
| 1 | RFOUT1 | At the High gain mode, RF output terminal. This terminal doubles as the drain terminal of the LNA. Please connect this terminal to the power supply(VDD) via inductor(L1). |
| 2 | NC(GND) | No connected terminal. This terminal is not connected with internal circuit. |
| 3 | RFOUT2 | At the Low gain mode, RF output terminal. Please connect this terminal with RFOUT1 terminal through DC blocking capacitor(C2) shown in the application circuit. |
| 4 | RFIN | RF input terminal. External capacitor C1 is required to block the DC bias voltage of internal circuit. |
| 5 | GND | Ground terminal. This terminal should be connected to the ground plane as close as possible for excellent RF performance. |
| 6 | VCTL | Control voltage terminal. |
| Exposed Pad | GND | Ground terminal. Please connect Exposed Pad with GND by using the plated through holes. |

ELECTRICAL CHARACTERISTICS (High Gain mode)

Conditions: $V_{DD}=5.0V$, $V_{CTL}=1.8V$, $T_a=25^\circ C$, $Z_s=Z_l=50\text{ ohm}$, with application circuit

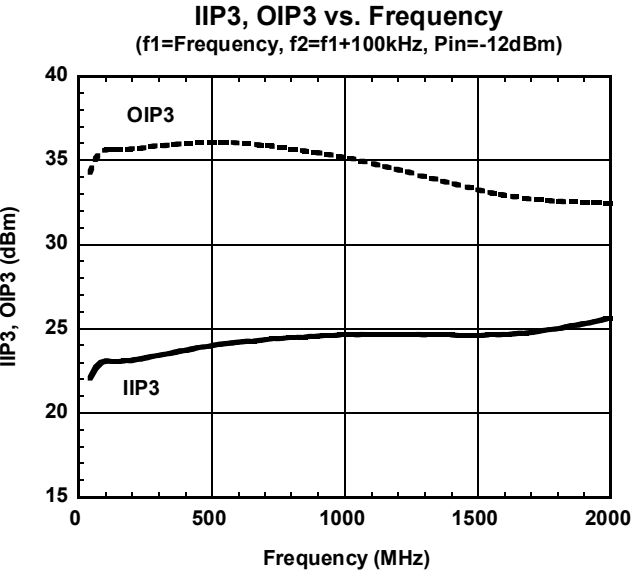
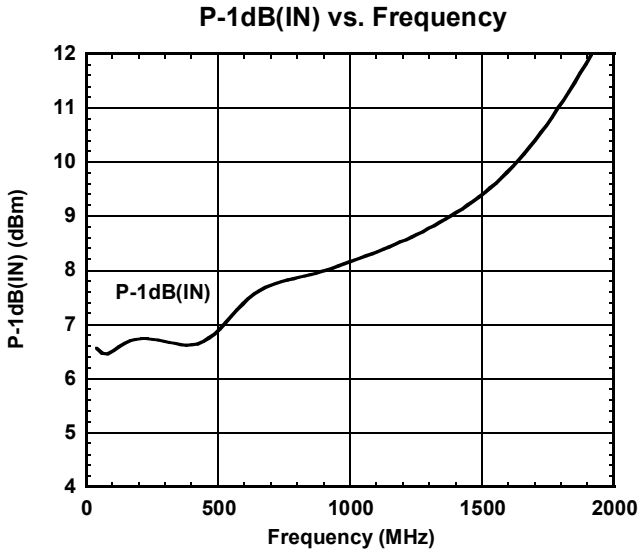
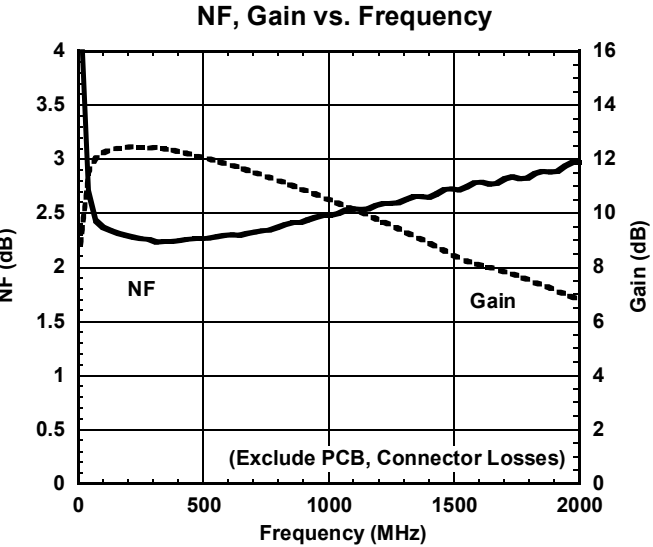
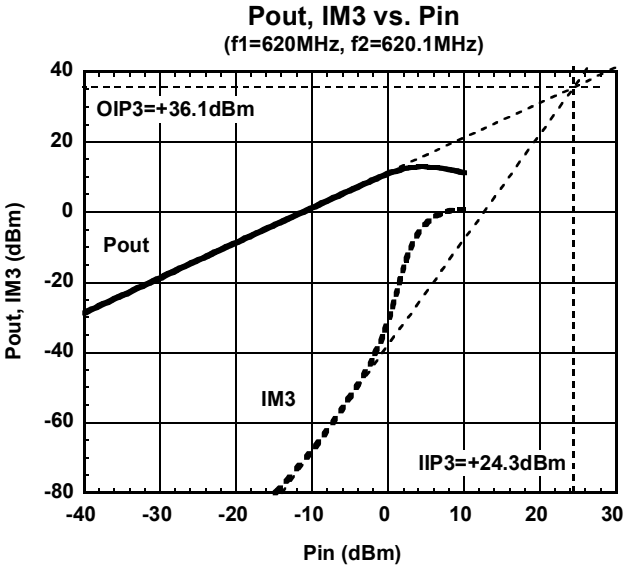
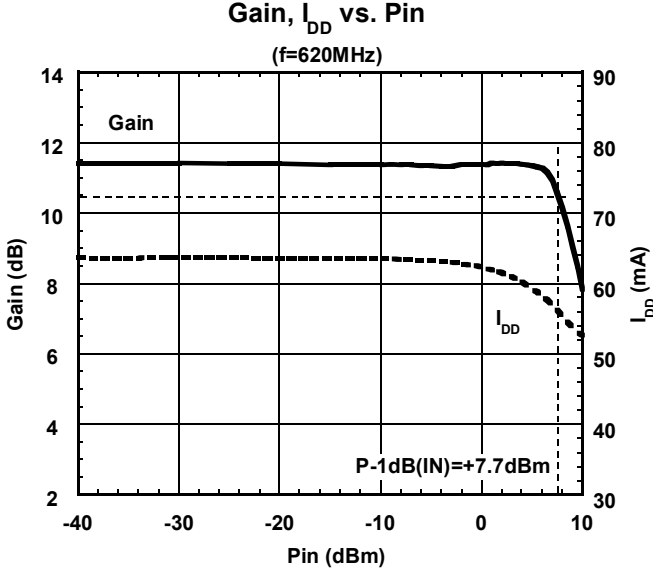
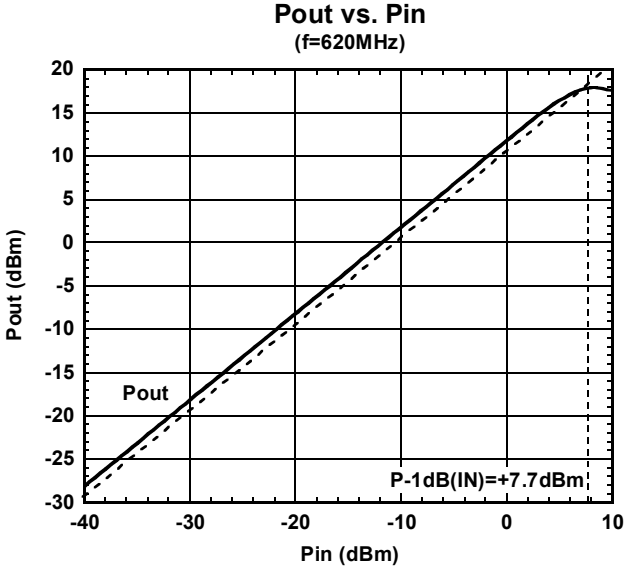

NJG1146KG1

■ ELECTRICAL CHARACTERISTICS (High Gain mode)

Conditions: $V_{DD}=5.0V$, $V_{CTL}=1.8V$, $T_a=25^\circ C$, $Z_s=Z_l=50\ \text{ohm}$, with application circuit

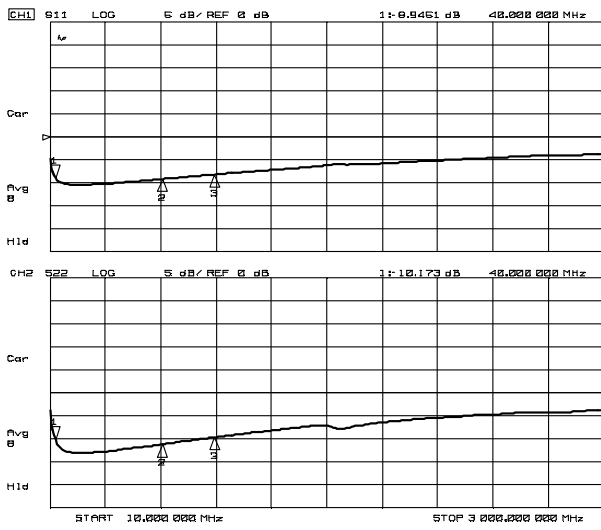

S11, S22 (f=10MHz~3GHz)

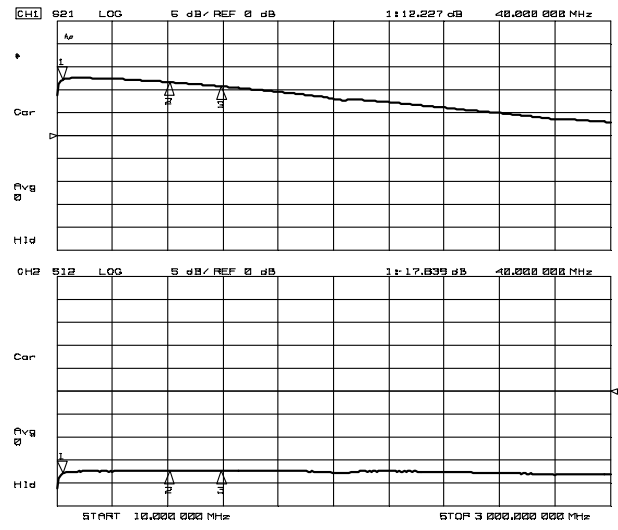

S21, S12 (f=10MHz~3GHz)

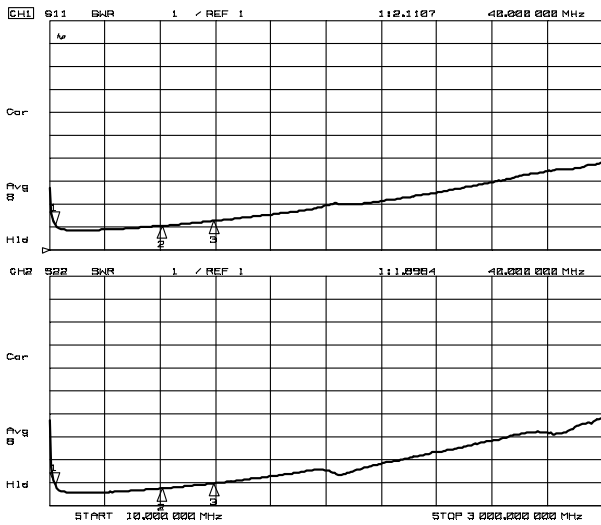

VSWR (f=10MHz~3GHz)

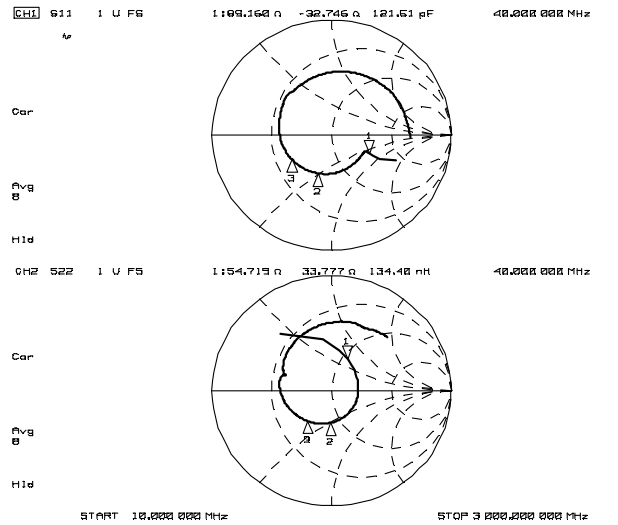

Zin, Zout (f=10MHz~3GHz)

ELECTRICAL CHARACTERISTICS (High Gain mode)

Conditions: $V_{DD}=5.0V$, $V_{CTL}=1.8V$, $T_a=25^\circ C$, $Z_s=Z_l=50\text{ ohm}$, with application circuit

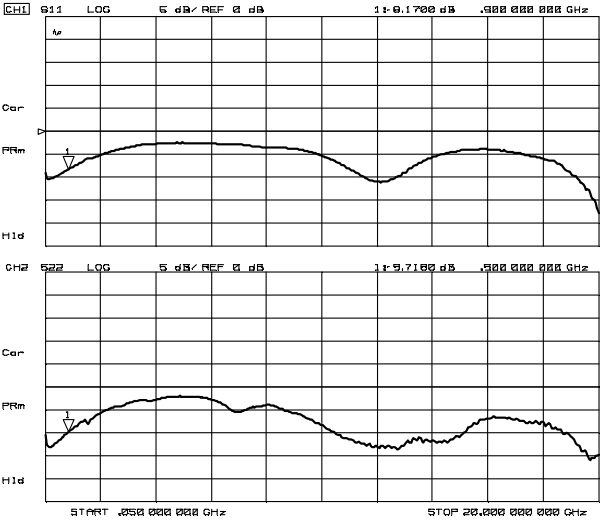

S11, S22 (f=50MHz~20GHz)

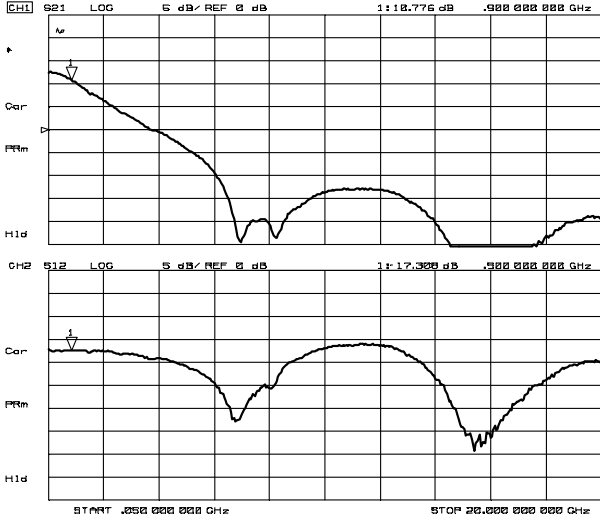

S21, S12 (f=50MHz~20GHz)

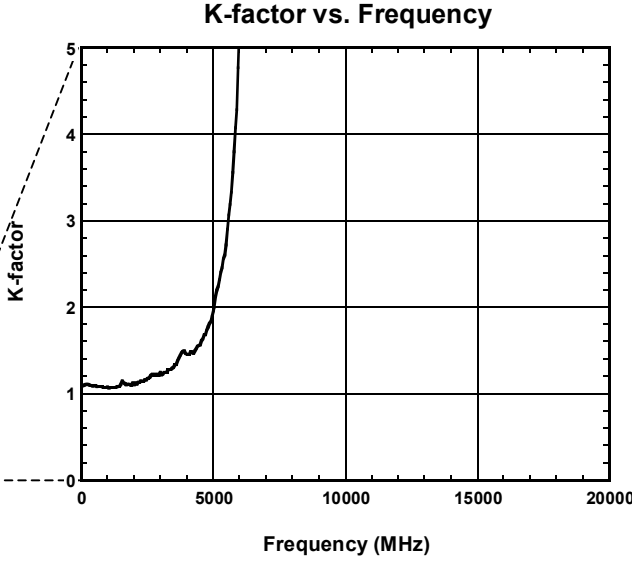
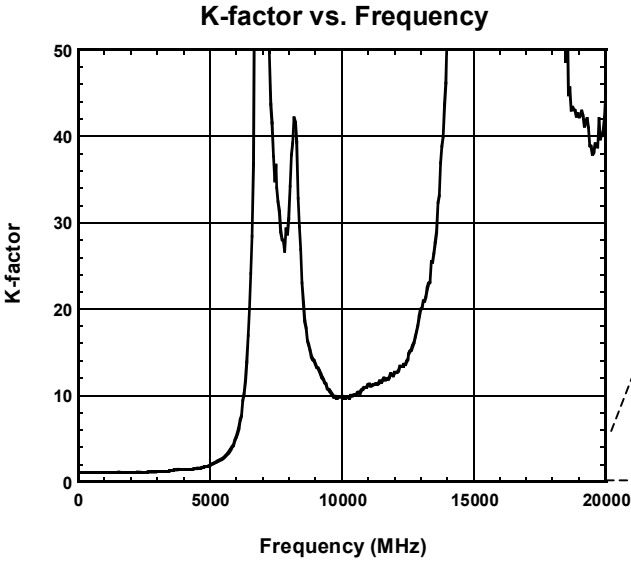

NJG1146KG1

■ ELECTRICAL CHARACTERISTICS (High Gain mode)

Conditions: $V_{CTL}=1.8V$, $T_a=25^\circ C$, $Z_s=Z_l=50\ \text{ohm}$, with application circuit

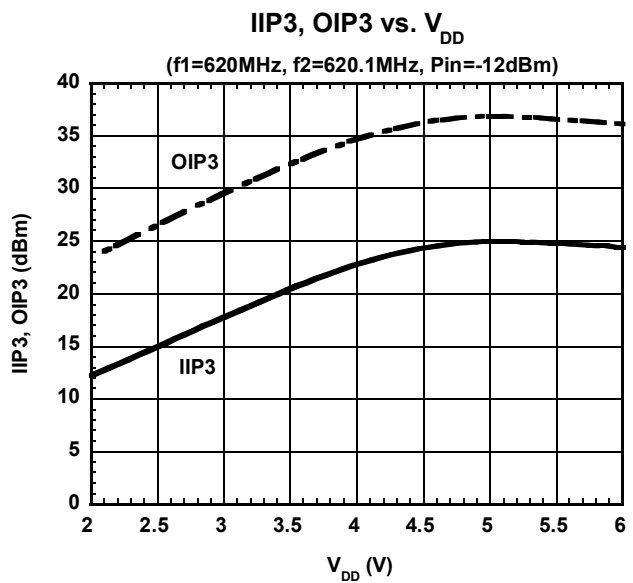
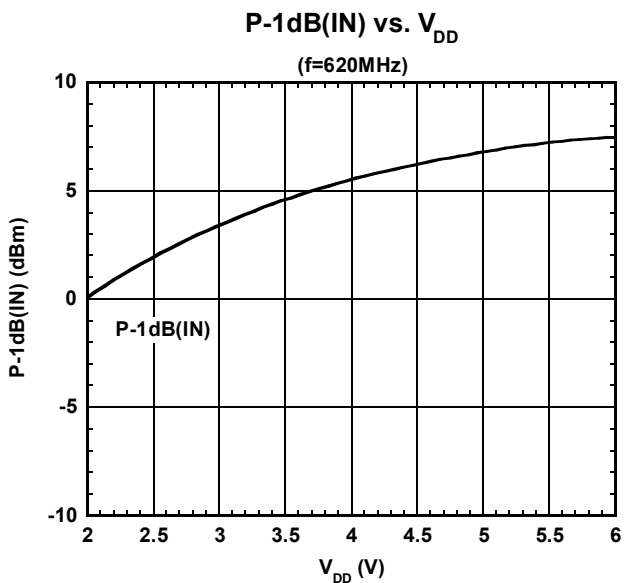
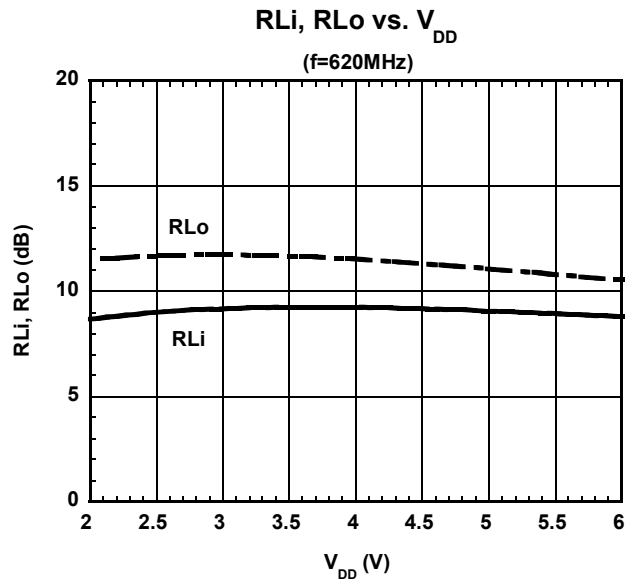
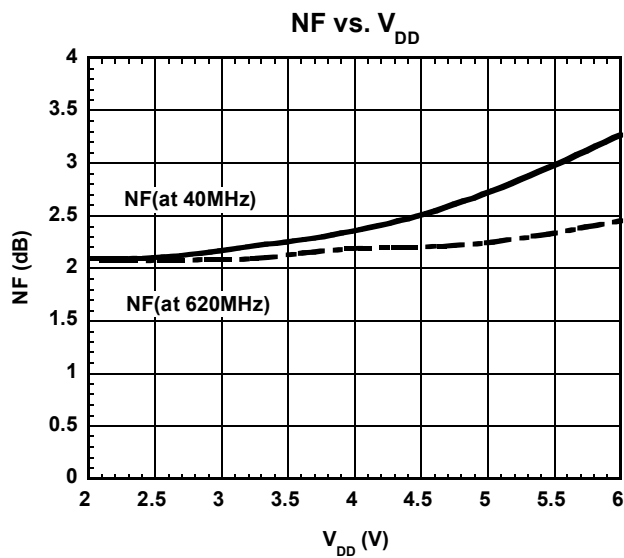
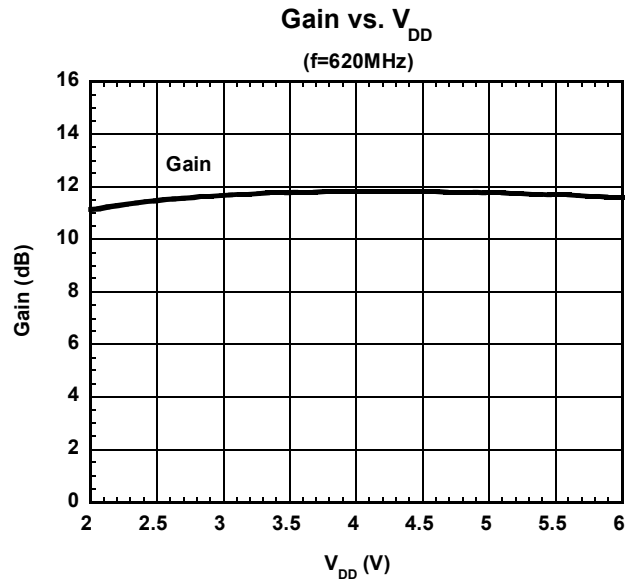
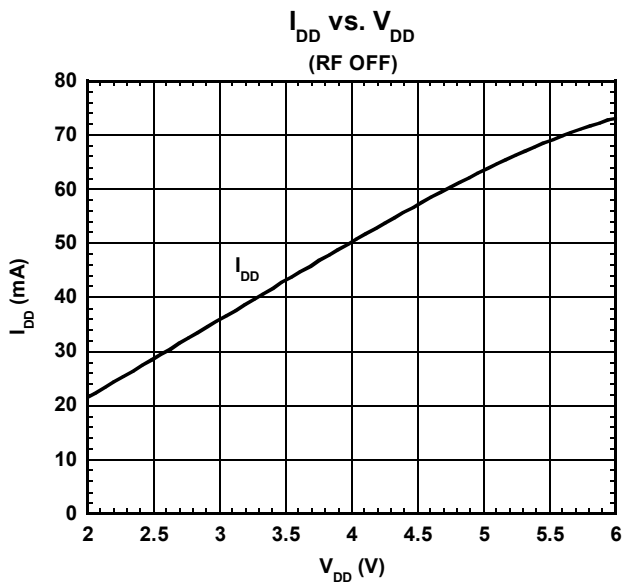

■ ELECTRICAL CHARACTERISTICS (High Gain mode)

Conditions: $V_{CTL}=1.8V$, $T_a=25^\circ C$, $Z_s=Z_l=50\text{ ohm}$, with application circuit

IM2 vs. V_{DD}

($f_1=200\text{MHz}$, $f_2=500\text{MHz}$, $f_{meas}=700\text{MHz}$, $\text{Pin1}=\text{Pin2}=-15\text{dBm}$)

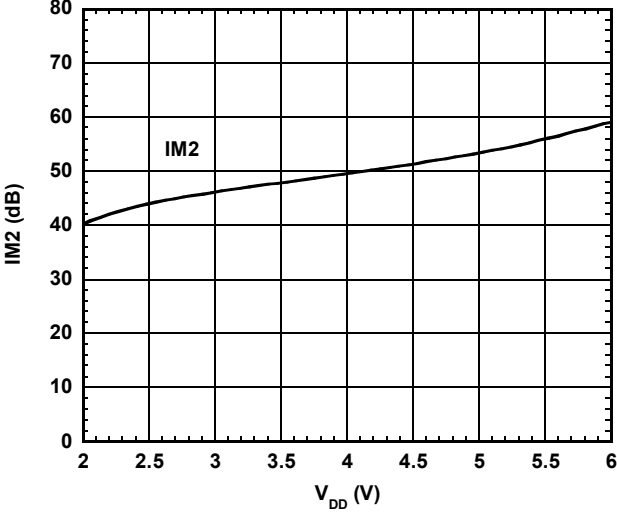

IM3 vs. V_{DD}

($f_1=600\text{MHz}$, $f_2=650\text{MHz}$, $f_{meas}=700\text{MHz}$, $\text{Pin1}=\text{Pin2}=-15\text{dBm}$)

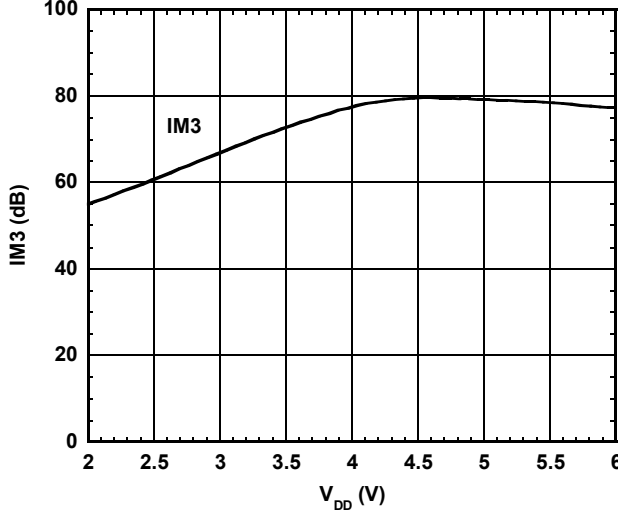

K-factor vs. Frequency

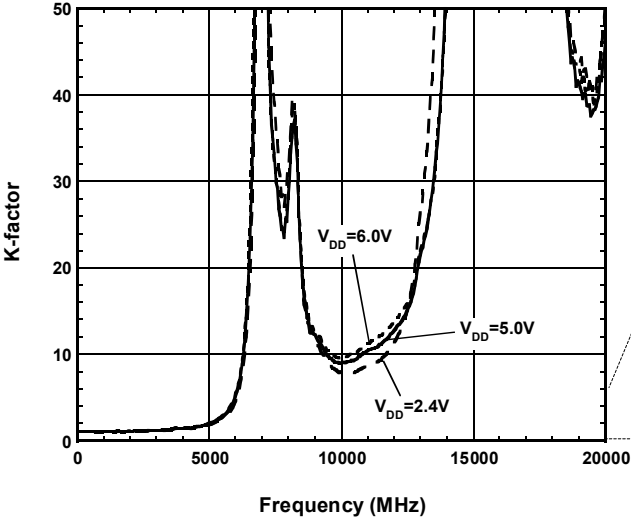

K-factor vs. Frequency

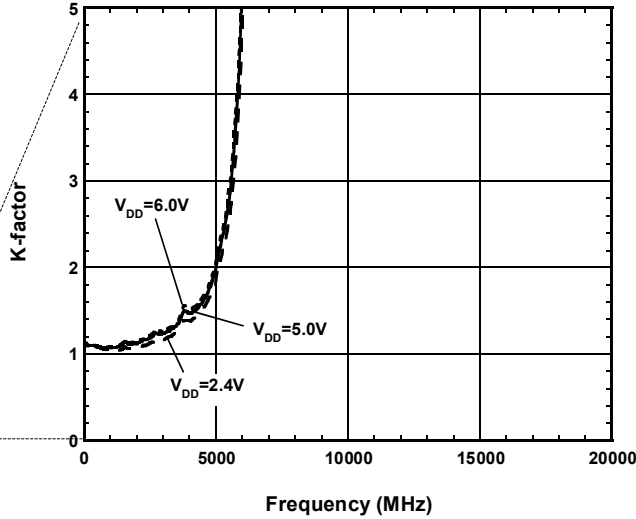

NJG1146KG1

■ ELECTRICAL CHARACTERISTICS (High Gain mode)

Conditions: $V_{DD}=5.0V$, $V_{CTL}=1.8V$, $Z_s=Z_l=50\text{ ohm}$, with application circuit

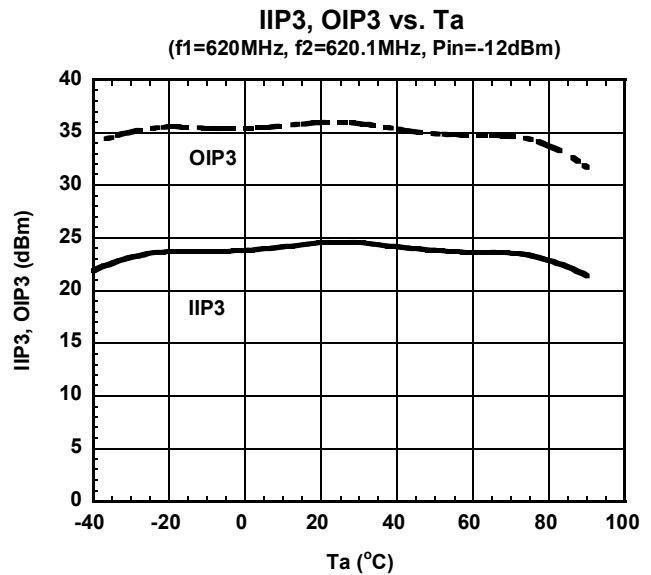
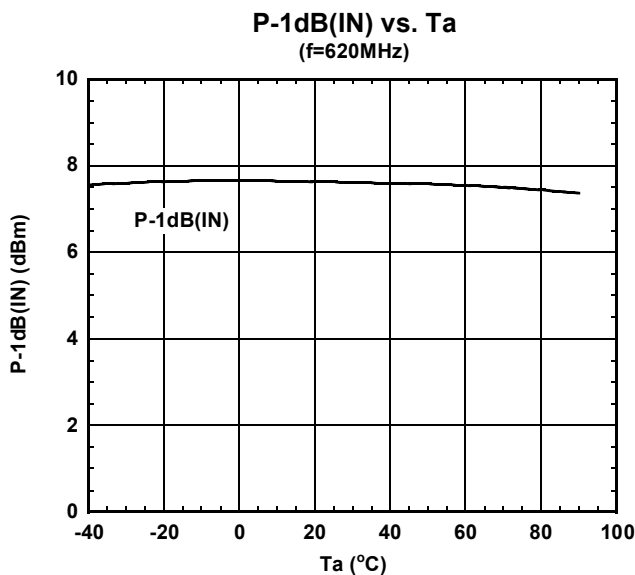
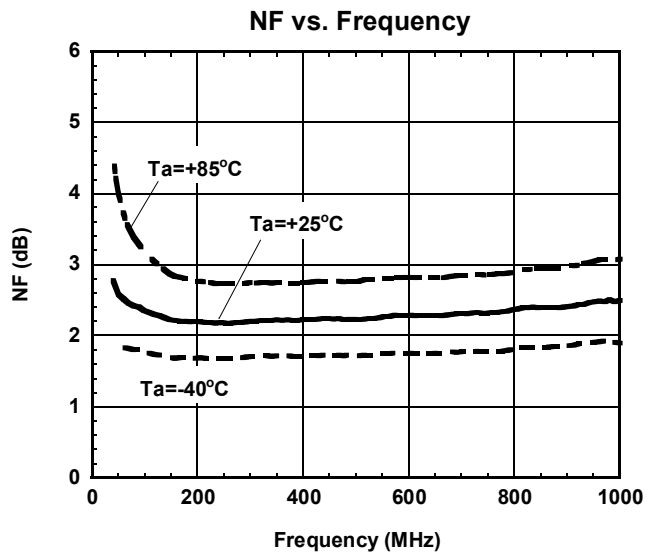
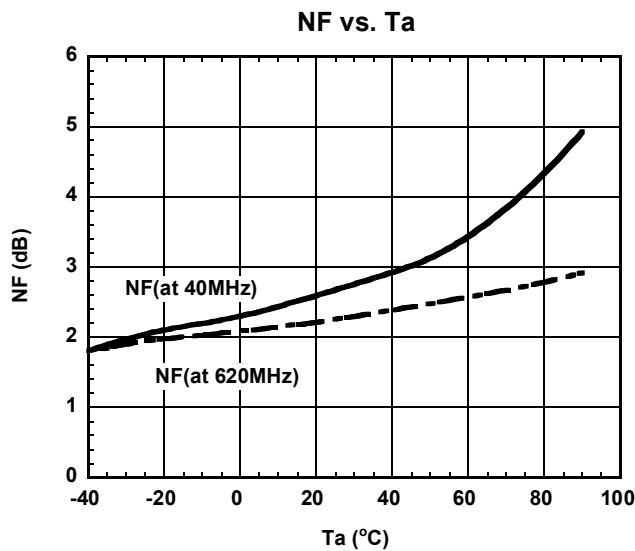
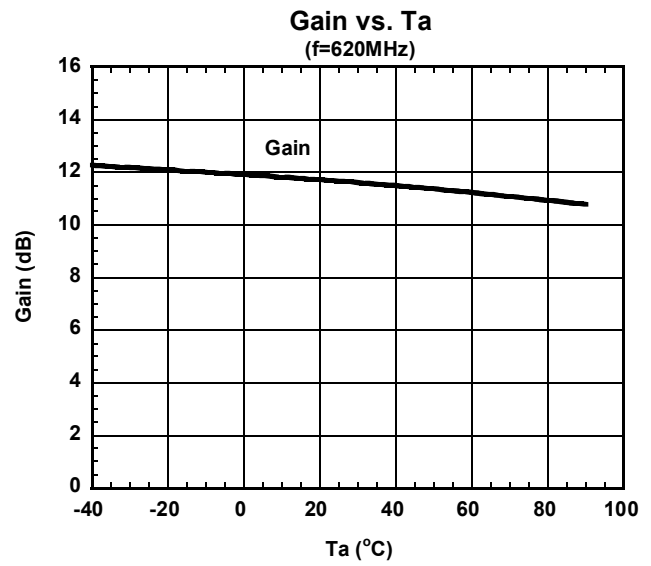
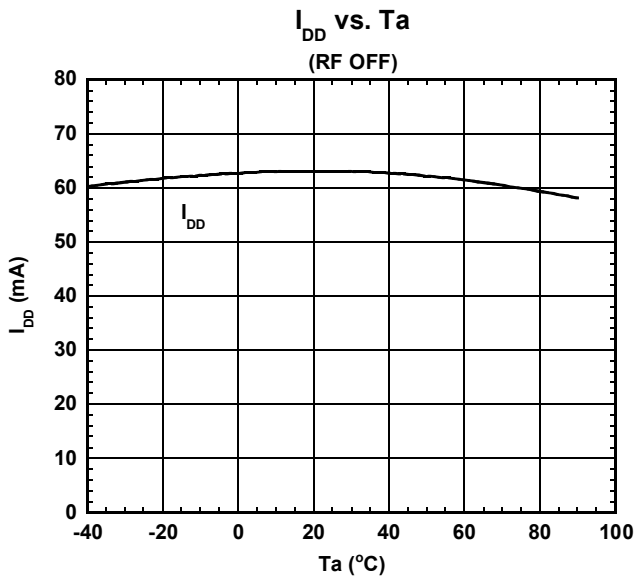

■ ELECTRICAL CHARACTERISTICS (High Gain mode)

Conditions: $V_{DD}=5.0V$, $V_{CTL}=1.8V$, $Z_s=Z_l=50\text{ ohm}$, with application circuit

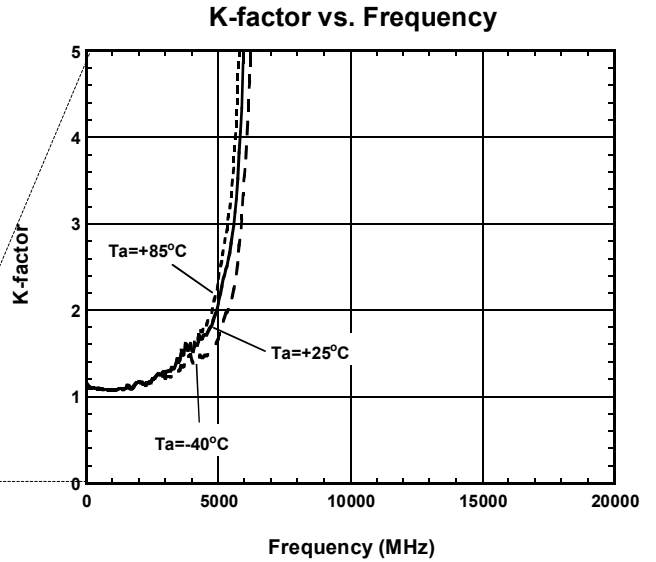
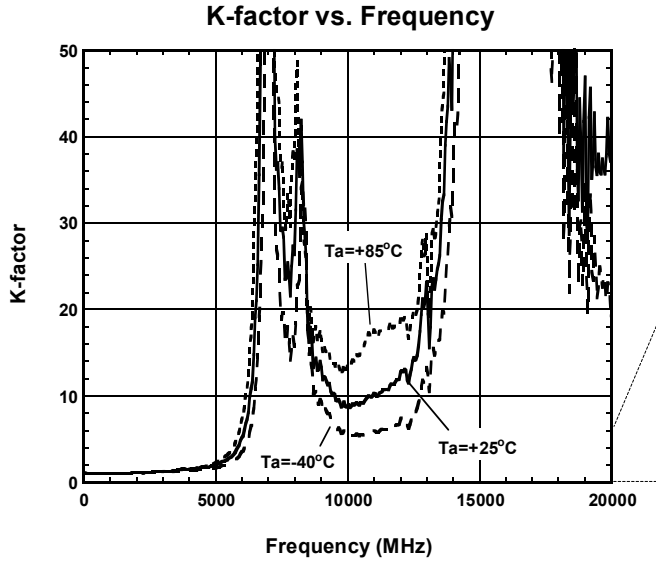
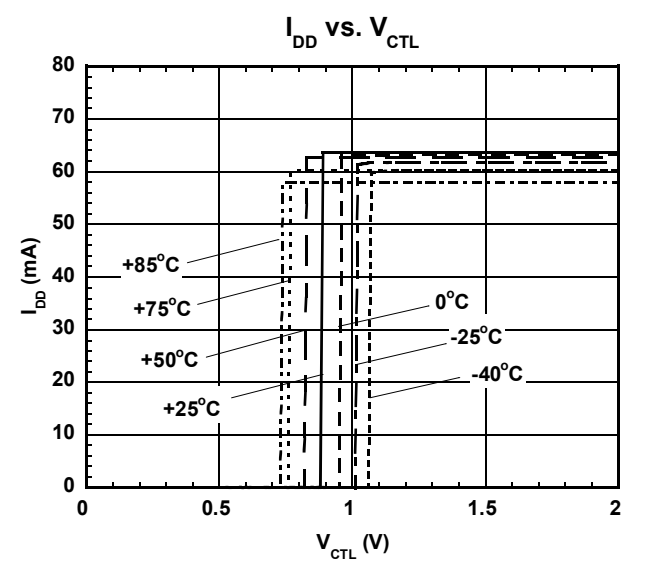
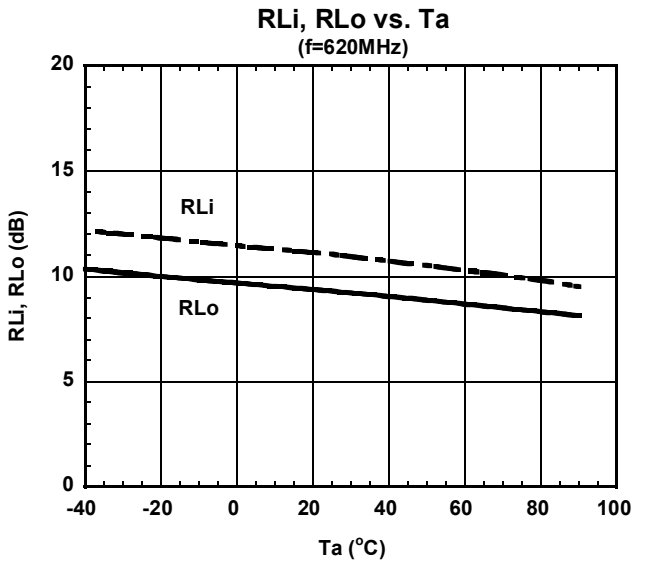
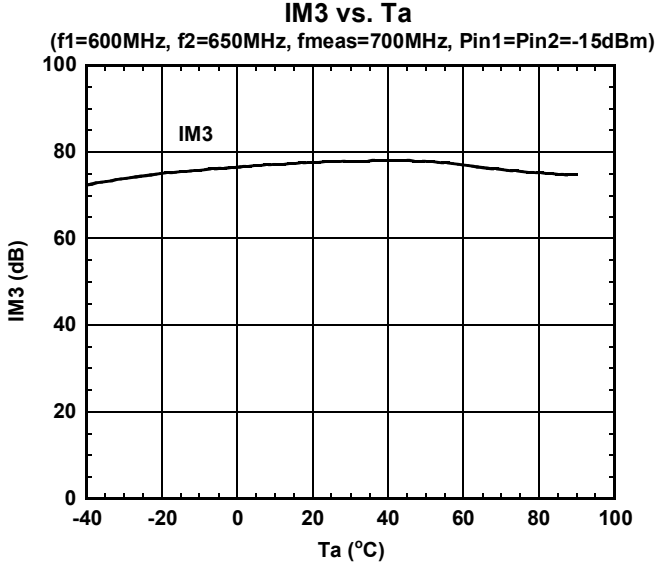
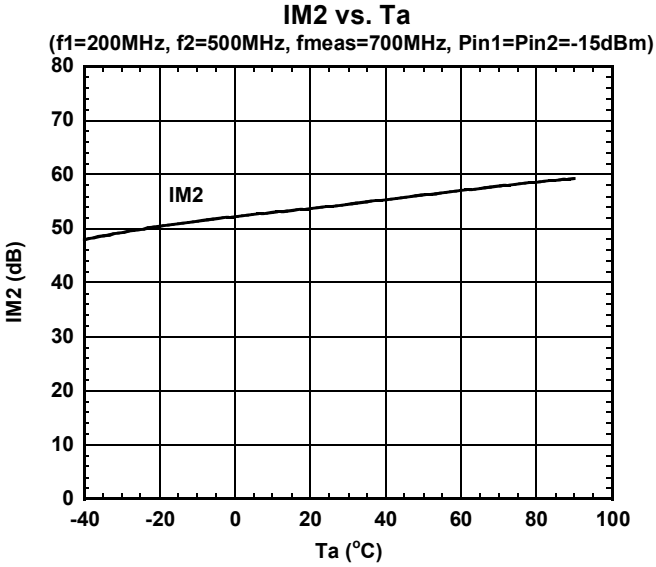

NJG1146KG1

■ ELECTRICAL CHARACTERISTICS (Low Gain mode)

Conditions: $V_{DD}=5.0V$, $V_{CTL}=0V$, $T_a=25^\circ C$, $Z_s=Z_l=50\ \text{ohm}$, with application circuit

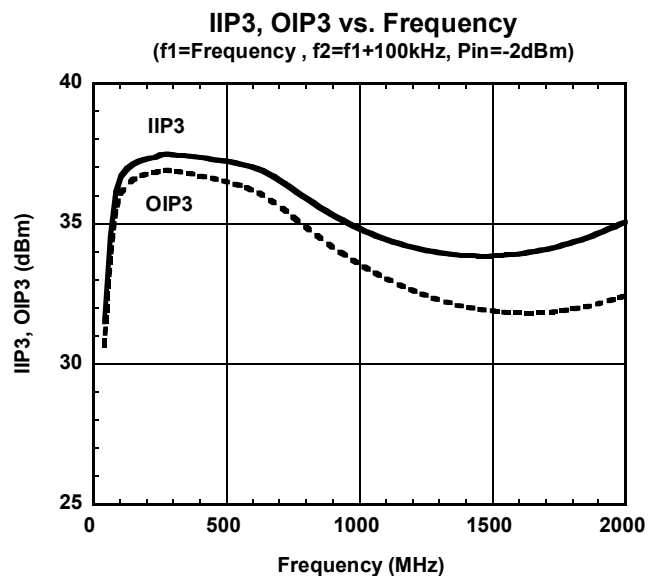
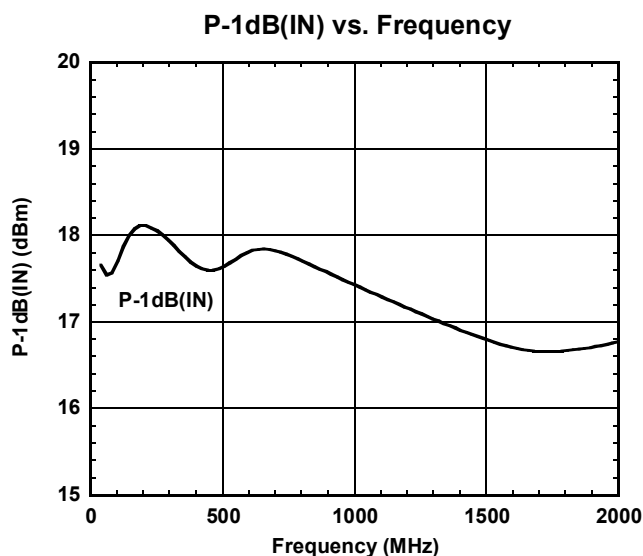
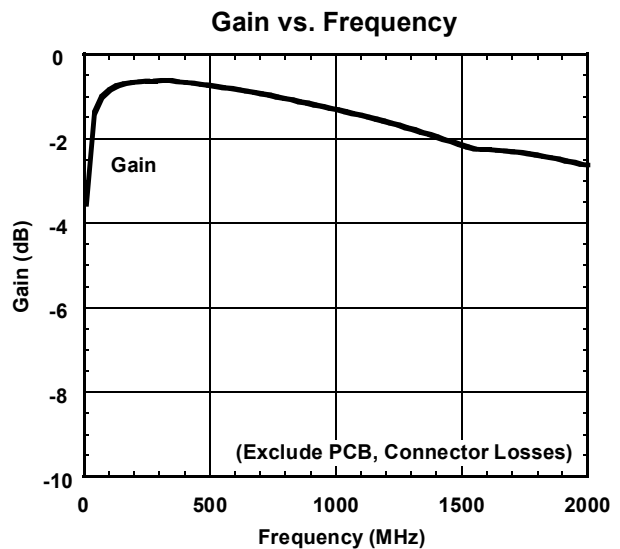
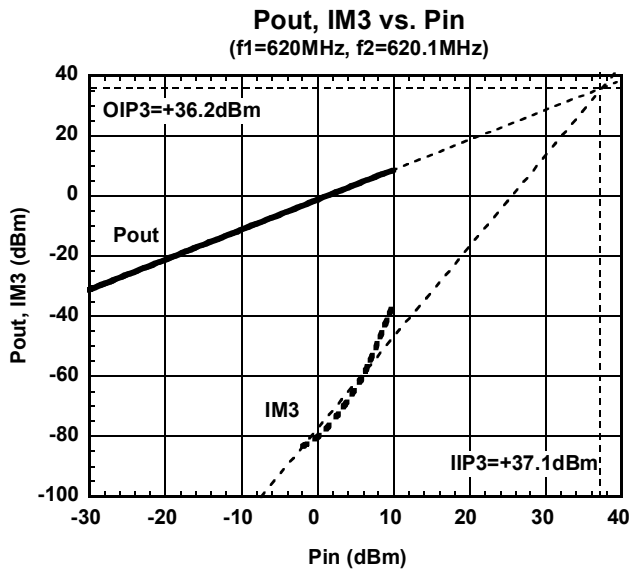
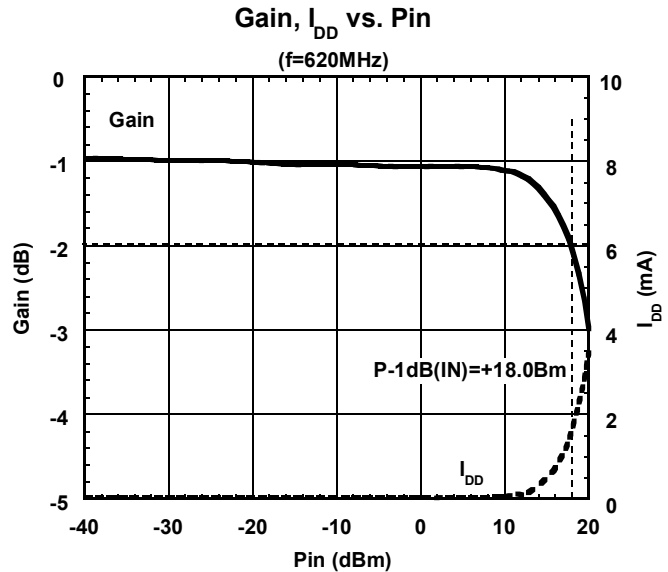
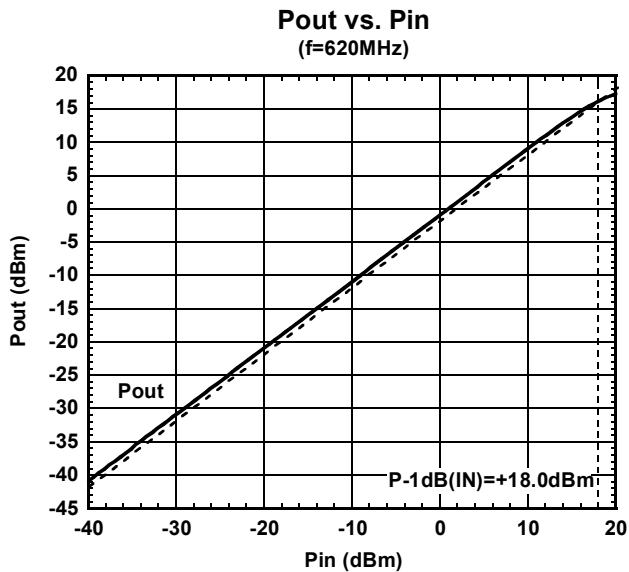

ELECTRICAL CHARACTERISTICS (Low Gain mode)

Conditions: $V_{DD}=5.0V$, $V_{CTL}=0V$, $T_a=25^\circ C$, $Z_s=Z_l=50\ \text{ohm}$, with application circuit

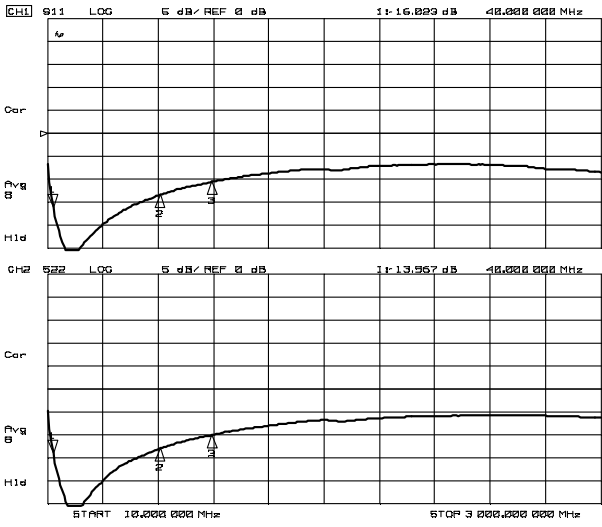

S11, S22 (f=10MHz~3GHz)

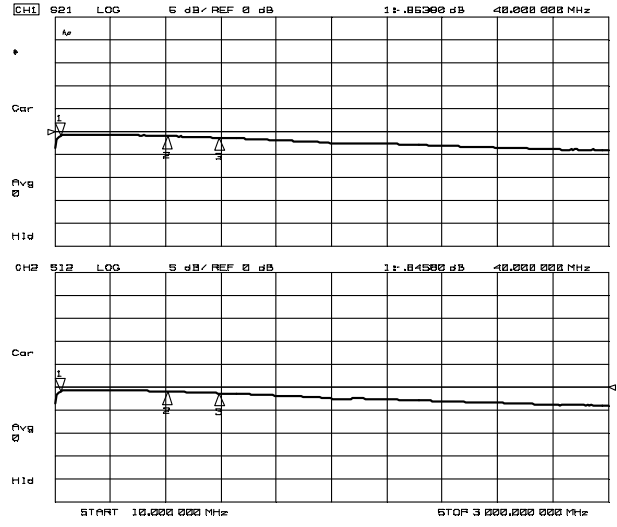

S21, S12 (f=10MHz~3GHz)

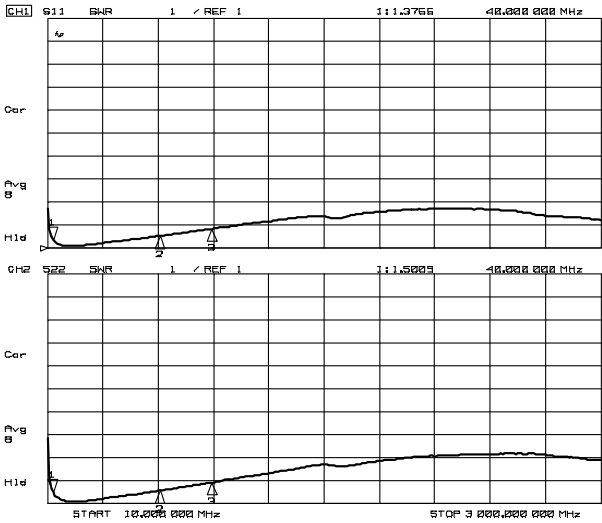

VSWR (f=10MHz~3GHz)

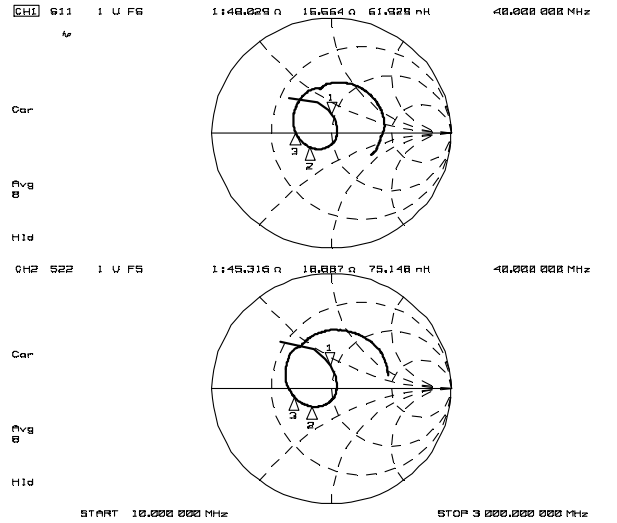

Zin, Zout (f=10MHz~3GHz)

NJG1146KG1

■ ELECTRICAL CHARACTERISTICS (Low Gain mode)

Conditions: $V_{DD}=5.0V$, $V_{CTL}=0V$, $T_a=25^\circ C$, $Z_s=Z_l=50\text{ ohm}$, with application circuit

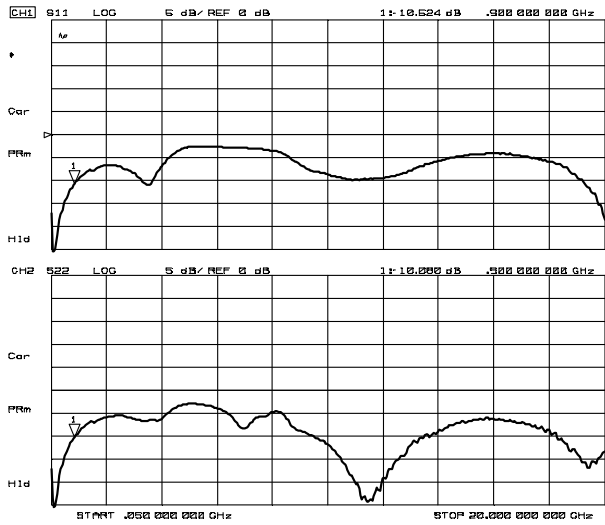

S11, S22 (f=50MHz~20GHz)

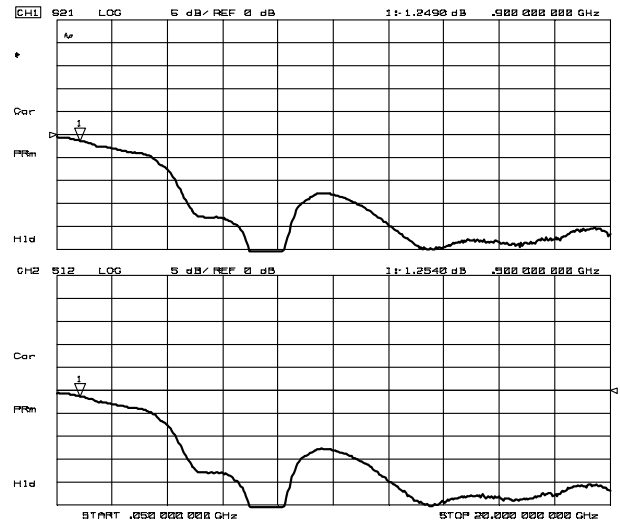

S21, S12 (f=50MHz~20GHz)

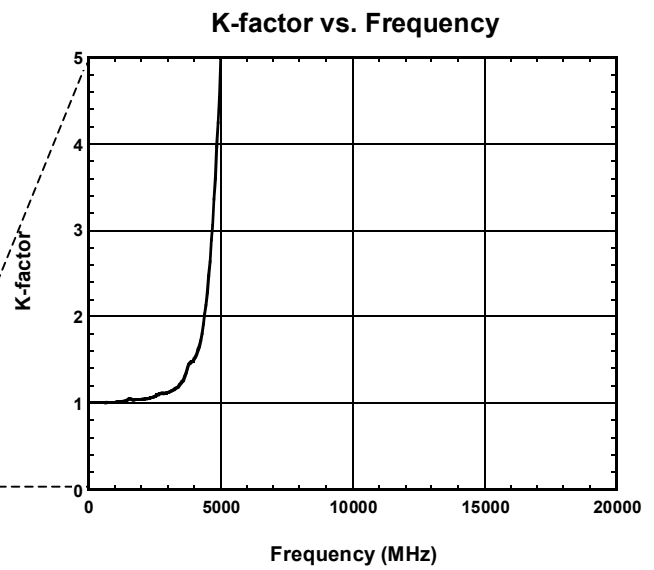
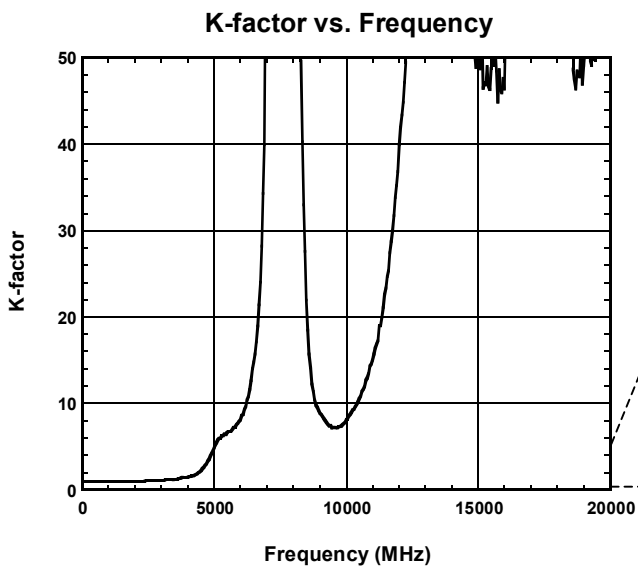

ELECTRICAL CHARACTERISTICS (Low Gain mode)

Conditions: $V_{DD}=5.0V$, $V_{CTL}=0V$, $Z_s=Z_l=50\text{ ohm}$, with application circuit

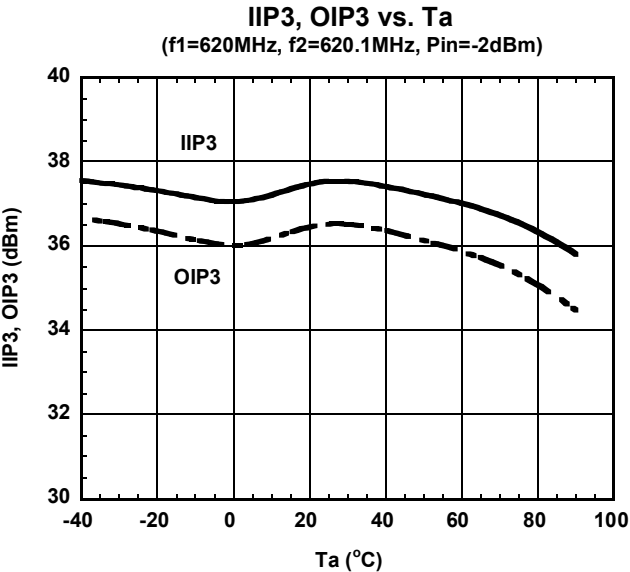
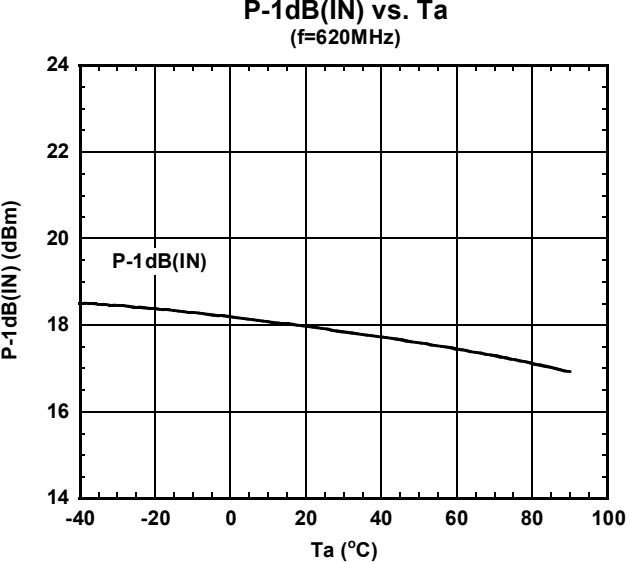
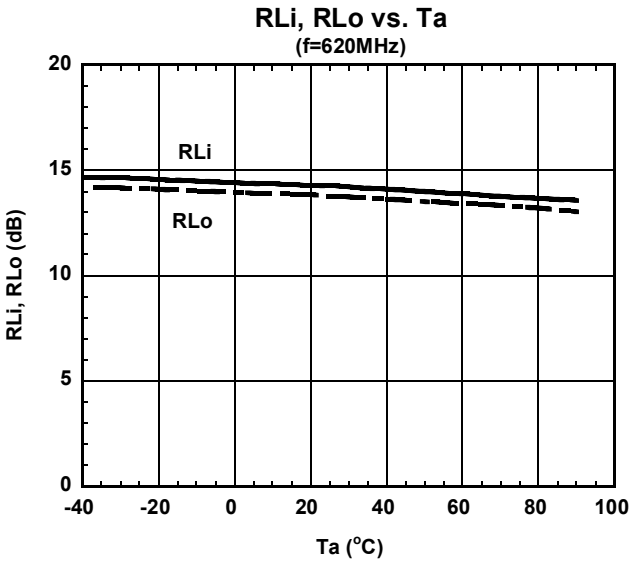
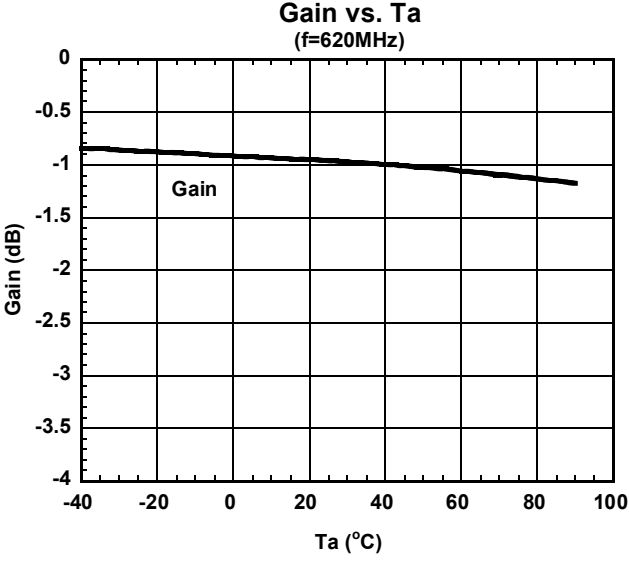
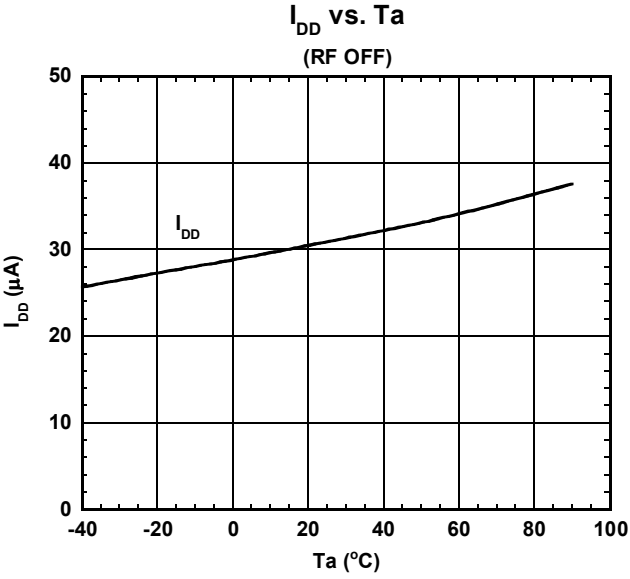

NJG1146KG1

■ ELECTRICAL CHARACTERISTICS (Low Gain mode)

Conditions: $V_{DD}=5.0V$, $V_{CTL}=0V$, $Z_s=Z_l=50\text{ ohm}$, with application circuit

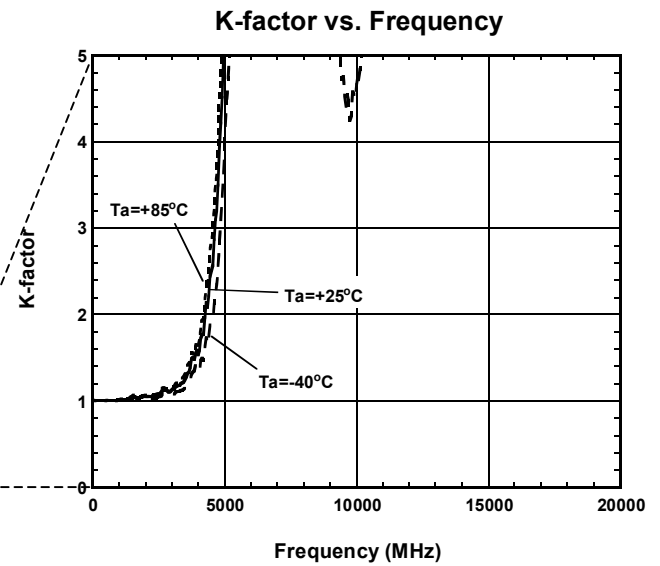
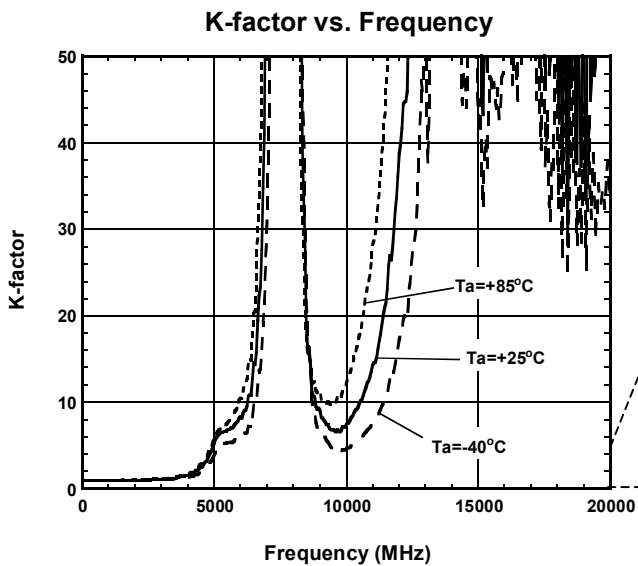
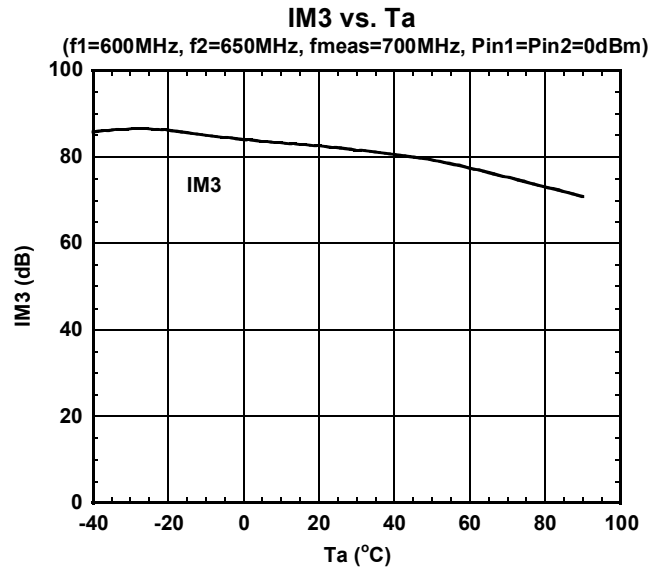
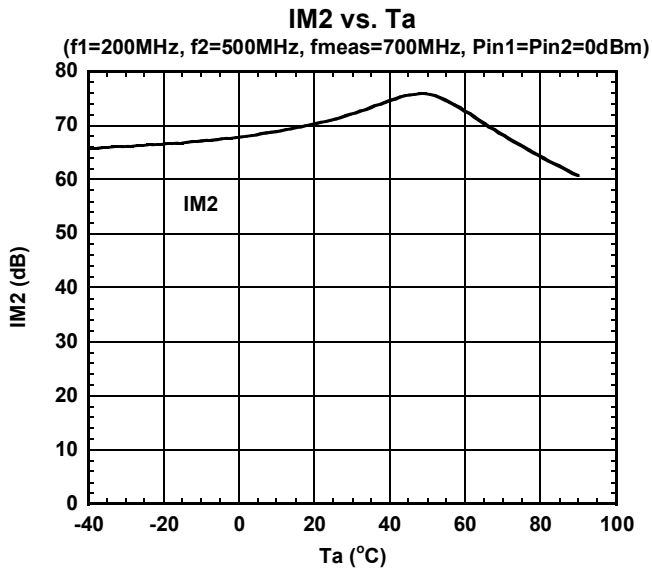

APPLICATION CIRCUIT

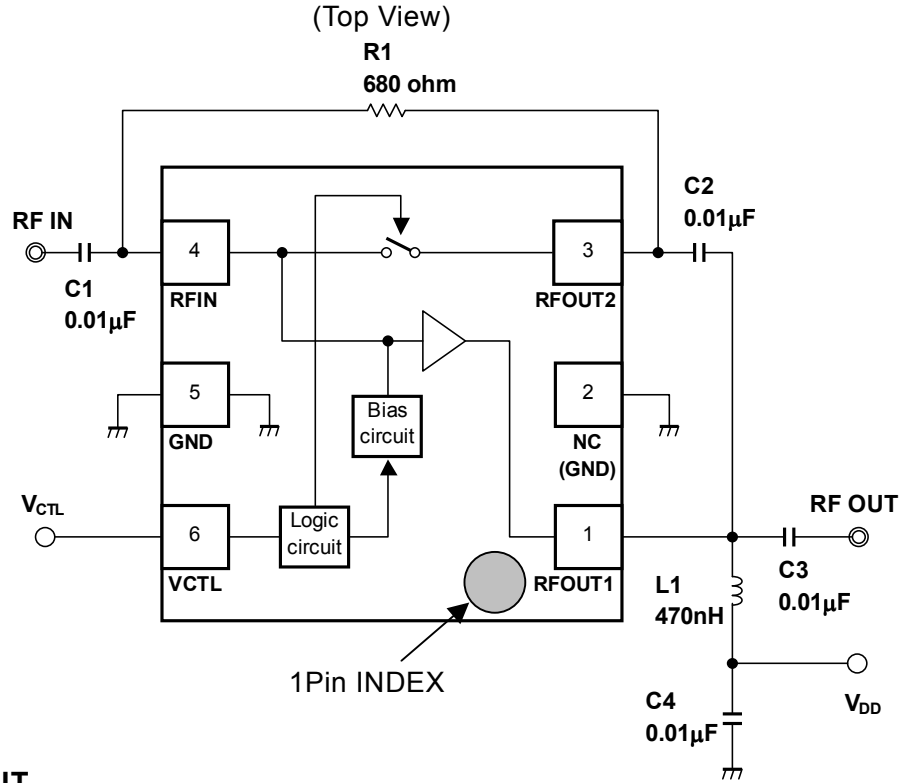

TEST PCB LAYOUT

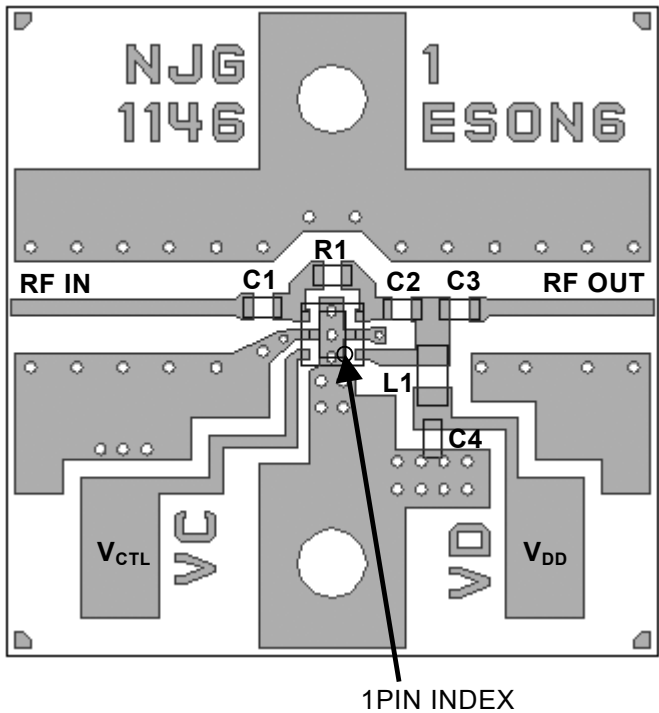

PARTS LIST

| Parts ID. | Manufacturer |
|-----------|------------------------------|
| L1 | TAIYO-YUDEN HK1608 Series |
| C1~C4 | MURATA GRM15 Series |
| R1 | KOA RK73B Series |

PCB (FR-4):
 t=0.2mm
 MICROSTRIP LINE WIDTH
 =0.40mm (Z₀=50 ohm)
 PCB SIZE=16.8mm x 16.8mm

PRECAUTIONS

- C1~C3 are DC-Blocking capacitors, and L1 is a DC-feed inductor, and C4 is a bypass capacitor.
- L1 is an RF choke. (DC feed inductor)
- Please connect Exposed Pad with GND by using the plated through hole.
- In order not to couple with terminal RFIN and RFOUT, please layout ground pattern under the IC.
- All external parts are placed as close as possible to the IC.

NJG1146KG1

MEASUREMENT BLOCK DIAGRAM

Measuring instruments

NF Analyzer : Agilent 8973A
Noise Source : Agilent 346A

Setting the NF analyzer

Measurement mode form

Device under test : Amplifier
System downconverter : off

Mode setup form

Sideband : LSB
Averages : 16
Average mode : Point
Bandwidth : 4MHz
Loss comp : off
Tcold : setting the temperature of noise source (303.15K)

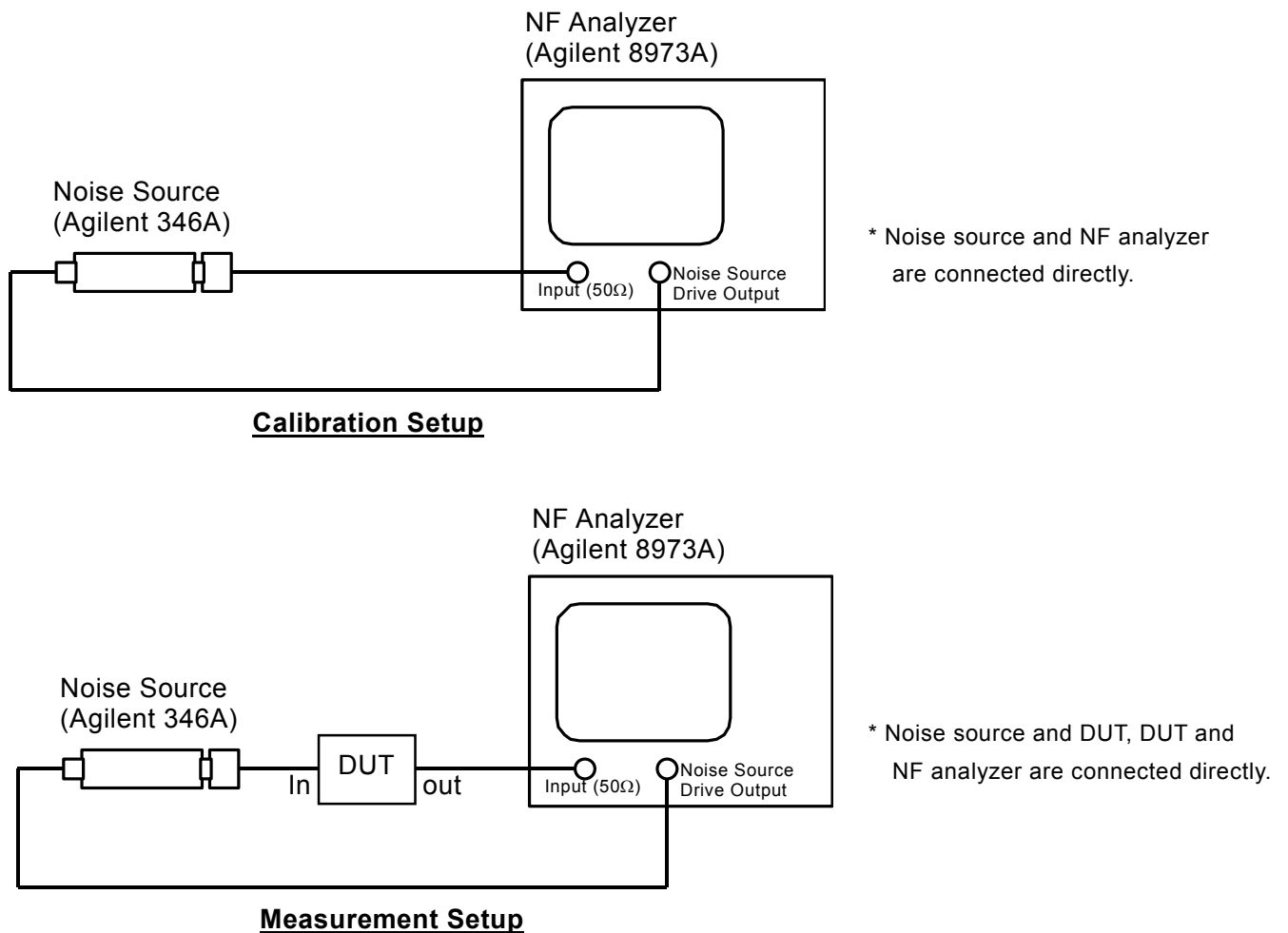

■ PACKAGE OUTLINE (ESON14-D7)

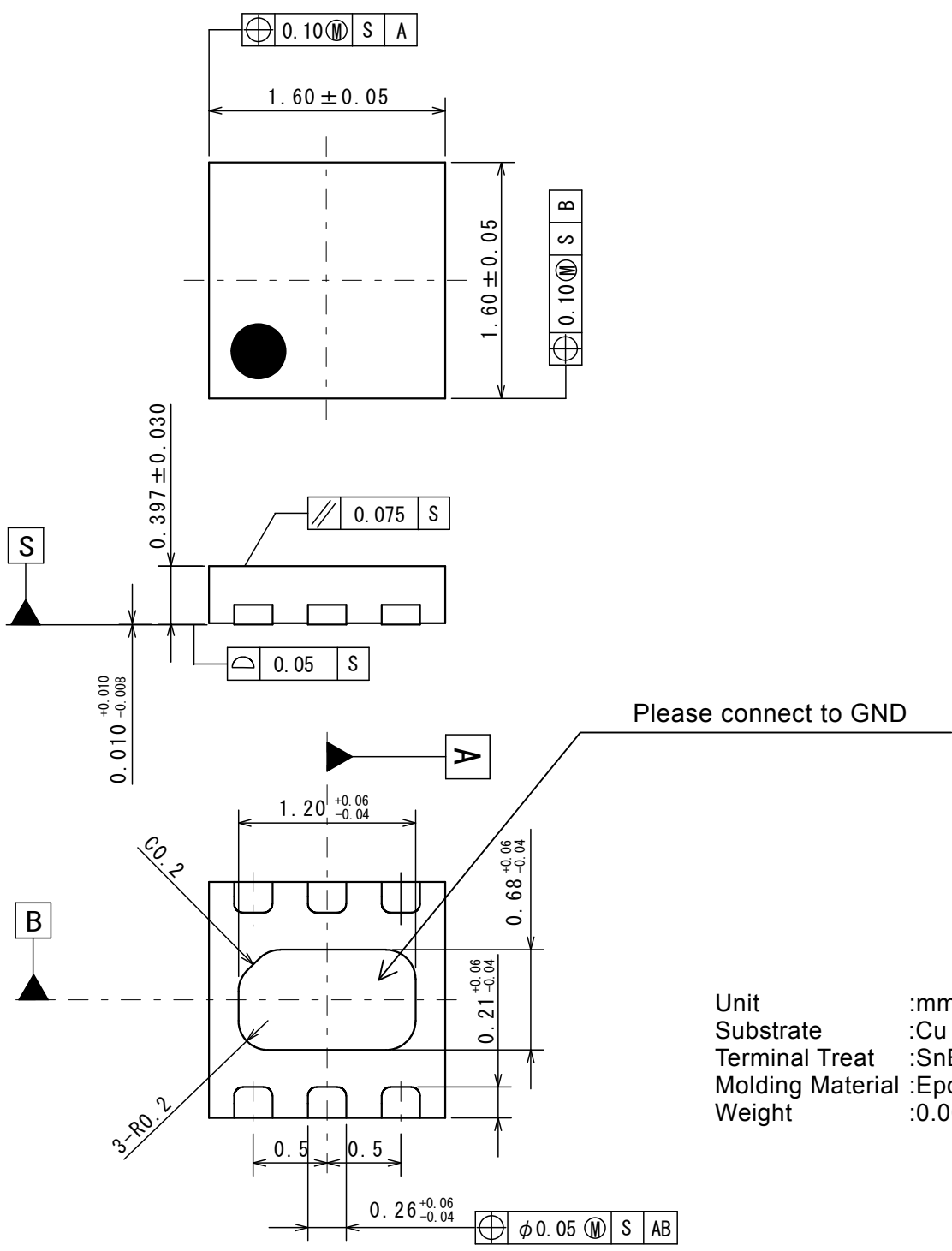

Unit :mm
 Substrate :Cu
 Terminal Treat :SnBi
 Molding Material :Epoxy Resin
 Weight :0.0035 (g)

Cautions on using this product
 This product contains Gallium-Arsenide (GaAs) which is a harmful material.

- Do NOT eat or put into mouth.
- Do NOT dispose in fire or break up this product.
- Do NOT chemically make gas or powder with this product.
- To waste this product, please obey the relating law of your country.

[CAUTION]
 The specifications on this databook are only given for information, without any guarantee as regards either mistakes or omissions. The application circuits in this databook are described only to show representative usages of the product and not intended for the guarantee or permission of any right including the industrial rights.

This product may be damaged with electric static discharge (ESD) or spike voltage. Please handle with care to avoid these damages.