

GNSS LOW NOISE AMPLIFIER

■ GENERAL DESCRIPTION

The NJG1108HA8 is a low noise amplifier GaAs MMIC designed for GNSS (Global Navigation Satellite Systems). This amplifier provides low noise figure, high gain and high IP3 operated by single low positive power supply. This IC has the function of Stand-by mode. The NJG1108HA8 can be tuned to wide frequency from 1.5GHz to 2.7GHz by changing the external matching components.

An ultra-small and ultra-thin package of the USB6-A8 is adopted.

■ PACKAGE OUTLINE

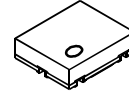

NJG1108HA8

■ APPLICATIONS

GNSS application, like GPS, Galileo, GLONASS and COMPASS
W-LAN and WiMAX application

Note: Please check the Application Note for WLAN and WiMAX.

■ FEATURES

- Operating frequency range 1.5~2.7GHz
- Low voltage operation +2.7V typ.
- Low current consumption 2.0mA typ. @ $V_{CTL}=1.85V$
1uA typ. @ $V_{CTL}=0V$
- High gain 19dB typ. @ $V_{CTL}=1.85V, f=1.575GHz$
- Low noise figure 1.0dB typ. @ $V_{CTL}=1.85V, f=1.575GHz$
- Input power at 1dB gain compression point -15.0dBm typ. @ $V_{CTL}=1.85V, f=1.575GHz$
- High input IP3 0dBm typ. @ $V_{CTL}=1.85V, f=1.575+1.5751GHz$
- Ultra-small and ultra-thin package USB6-A8 (Package size: 1.0x1.2x0.38mm)

■ PIN CONFIGURATION

(Top View)

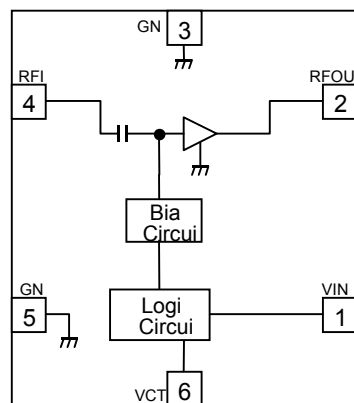

Pin Connection

1. VIN
2. RFOU
3. GND
4. RFIN
5. GND
6. VCTL

■ TRUTH TABLE

“H”= $V_{CTL(H)}$, “L”= $V_{CTL(L)}$

V_{CTL}	LNA Mode
H	Active Mode
L	Sleep Mode

Note: Specifications and description listed in this datasheet are subject to change without notice.

NJG1108HA8

■ABSOLUTE MAXIMUM RATINGS

$T_a=+25^{\circ}\text{C}$, $Z_s=Z_l=50\text{ohm}$

PARAMETER	SYMBOL	CONDITIONS	RATINGS	UNITS
Drain Voltage	V_{DD}		5.0	V
Inverter voltage	V_{INV}		5.0	V
Control voltage	V_{CTL}		5.0	V
Input power	P_{in}	$V_{DD}=2.7\text{V}$	+15	dBm
Power dissipation	P_D	On PCB board, $T_{jmax}=150^{\circ}\text{C}$	150	mW
Operating temperature	T_{opr}		-40~+85	$^{\circ}\text{C}$
Storage temperature	T_{stg}		-55~+150	$^{\circ}\text{C}$

■ELECTRICAL CHARACTERISTICS 1

GENERAL CONDITIONS: $V_{DD}=V_{INV}=2.7\text{V}$, $T_a=+25^{\circ}\text{C}$, $Z_s=Z_l=50\text{ohm}$, with application circuit

PARAMETERS	SYMBOL	CONDITIONS	MIN	TYP	MAX	UNITS
Operating voltage	V_{DD}		2.5	2.7	3.5	V
Inverter supply voltage	V_{INV}		2.5	2.7	3.5	V
Control voltage (High)	$V_{CTL(H)}$		1.5	1.85	$V_{INV}+0.3$	V
Control voltage (Low)	$V_{CTL(L)}$		0	0	0.3	V
Operating current1 (Active Mode, RF OFF)	I_{DD1}	RF OFF, $V_{CTL}=1.85\text{V}$	-	2.0	3.0	mA
Operating current2 (Sleep Mode, RF OFF)	I_{DD2}	RF OFF, $V_{CTL}=0\text{V}$	-	1	5	μA
Inverter current1	I_{INV1}	RF OFF, $V_{CTL}=1.85\text{V}$	-	30	60	μA
Inverter current2	I_{INV2}	RF OFF, $V_{CTL}=0\text{V}$	-	9	20	μA
Control current	I_{CTL}	RF OFF, $V_{CTL}=1.85\text{V}$	-	6	20	μA

■ ELECTRICAL CHARACTERISTICS 2 (Active Mode)

GENERAL CONDITIONS: $V_{DD}=V_{INV}=2.7V$, $V_{CTL}=1.85V$, $f_{RF}=1575MHz$, $T_a=+25^{\circ}C$, $Z_s=Z_l=50ohm$, with application circuit

PARAMETERS	SYMBOL	CONDITIONS	MIN	TYP	MAX	UNITS
Operating Frequency	freq		1.57	1.575	1.58	GHz
Small signal gain	Gain		17.0	19.0	21.5	dB
Noise figure	NF	Exclude PCB & connector losses (IN: 0.05dB)	-	1.0	1.2	dB
Input power at 1dB gain compression point	$P_{-1dB(IN)}$		-19.0	-15.0	-	dBm
Input 3rd order intercept point	IIP3	$f1=f_{RF}$, $f2=f_{RF}+100kHz$, $P_{in}=-34dBm$	-5.0	0	-	dBm
RF IN VSWR	VSWR _i		-	2.0	2.5	
RF OUT VSWR	VSWR _o		-	1.5	2.0	

NJG1108HA8

■ TERMINAL INFORMATION

No.	SYMBOL	DESCRIPTION
1	VINV	Power supply pin of the inverter circuit.
2	RFOUT	RF Output and voltage supply pin. External matching circuits and a bypass capacitor is required. L3 is a RF choke inductor. These elements are used as output matching circuit.
3	GND	Ground pin. To keep good RF grounding performance, please use multiple via holes to connect with ground plane and this pin.)
4	RFIN	RF input pin. A DC blocking capacitor is not required. An external matching circuit is required.
5	GND	Ground pin. To keep good RF grounding performance, please use multiple via holes to connect with ground plane and this pin.)
6	VCTL	Control voltage input pin. This control pin is set to high. LNA suffers from standby state when LNA puts the changeover voltage of "Low" in a state of movement when the changeover voltage of "High" is put in this terminal.

CAUTION

1) Ground terminal (3, 5) should be connected to the ground plane as low inductance as possible.

■ ELECTRICAL CHARACTERISTICS

(Conditions: $V_{DD}=V_{INV}=2.7V$, $V_{CTL}=1.85V$, $f_{RF}=1575MHz$, $T_a=+25^\circ C$, $Z_s=Z_l=50\Omega$, with application circuit)

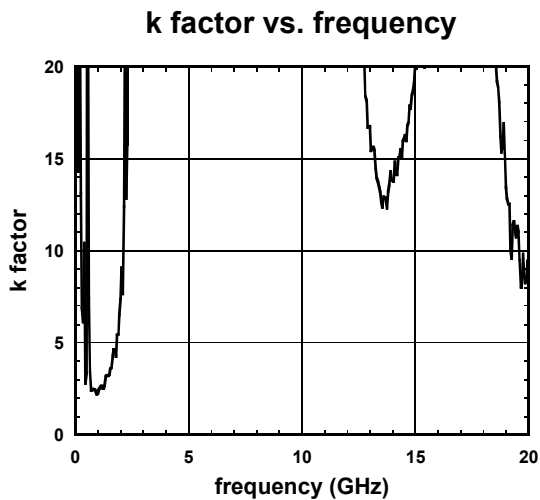
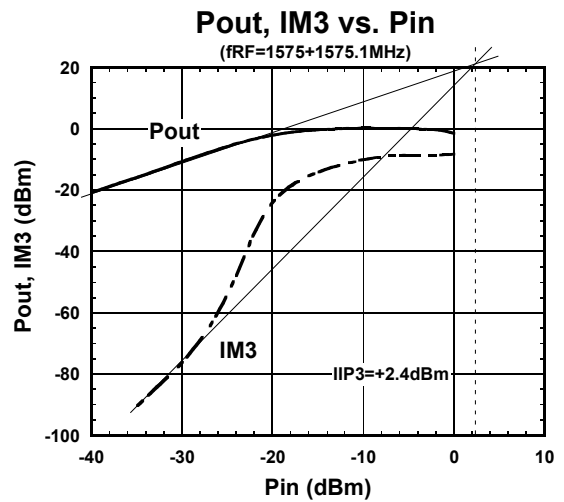
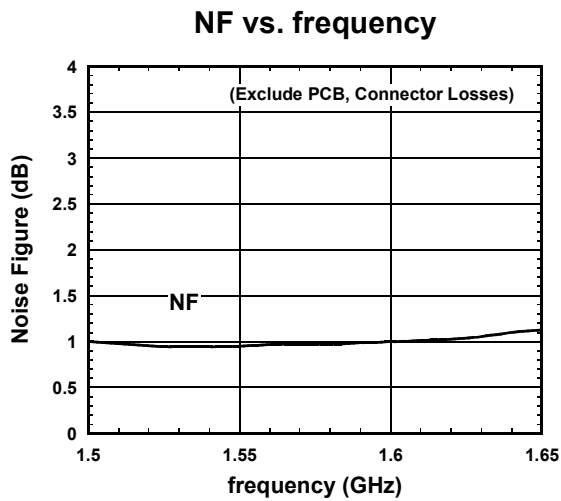
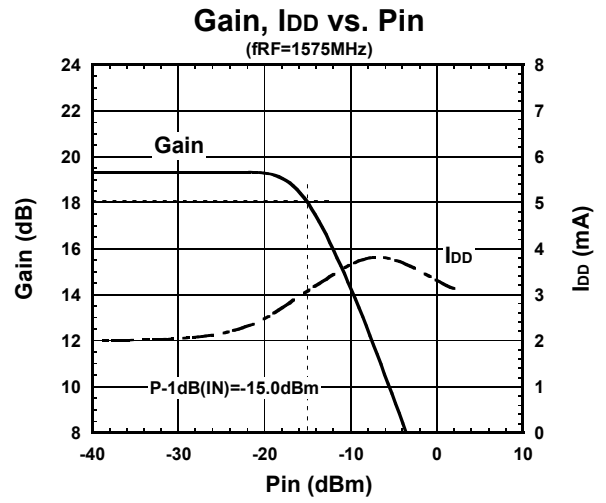
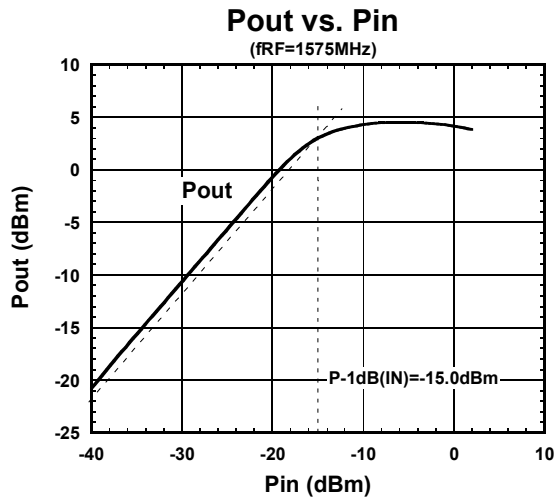

NJG1108HA8

■ ELECTRICAL CHARACTERISTICS

(Conditions: $V_{DD}=V_{INV}=2.7V$, $V_{CTL}=1.85V$, $f_{RF}=1575MHz$, $T_a=+25^\circ C$, $Z_s=Z_l=50\Omega$, with application circuit)

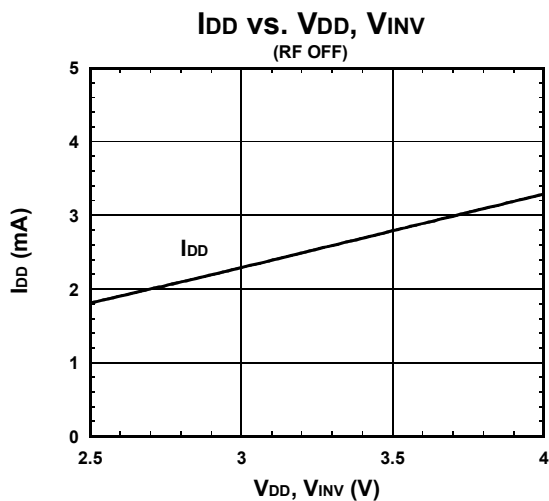
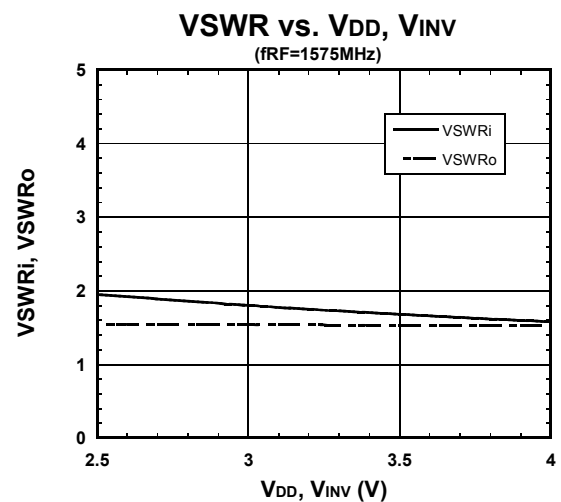
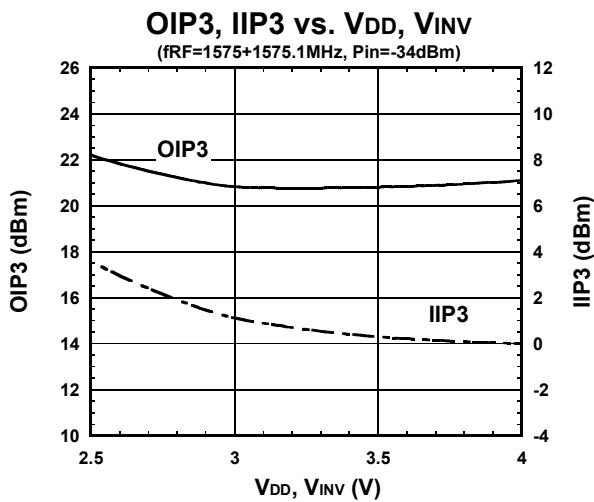
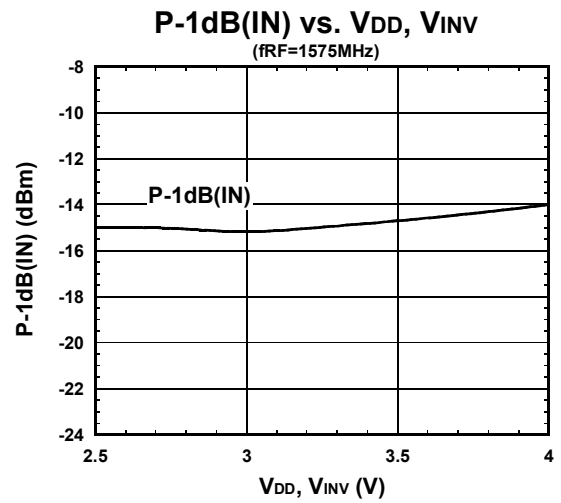
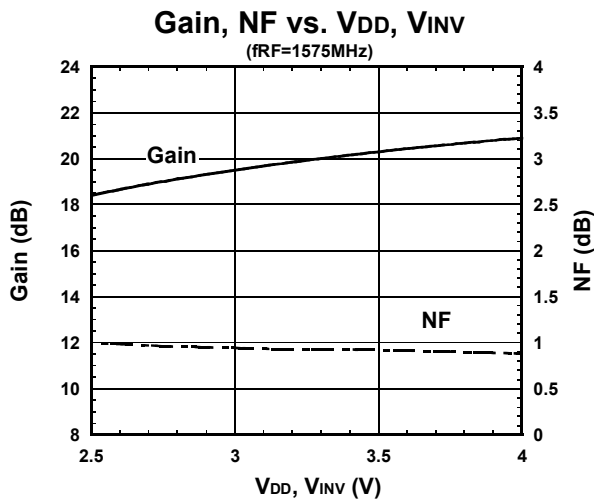

■ ELECTRICAL CHARACTERISTICS

(Conditions: $V_{DD}=V_{INV}=2.7V$, $V_{CTL}=1.85V$, $f_{RF}=1575MHz$, $T_a=+25^\circ C$, $Z_s=Z_l=50\Omega$, with application circuit)

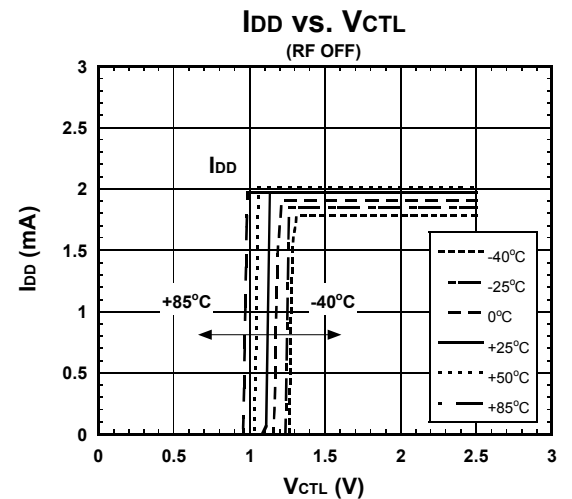
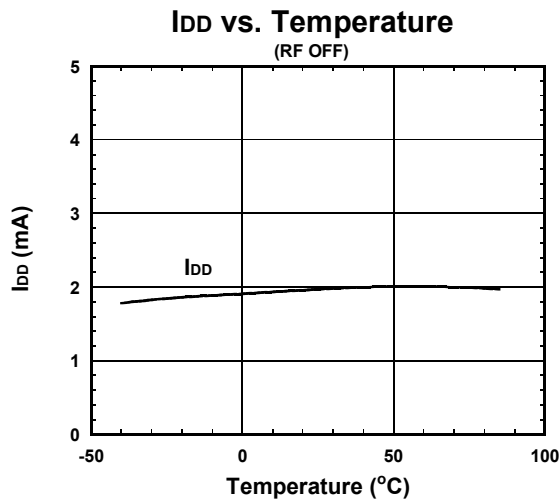
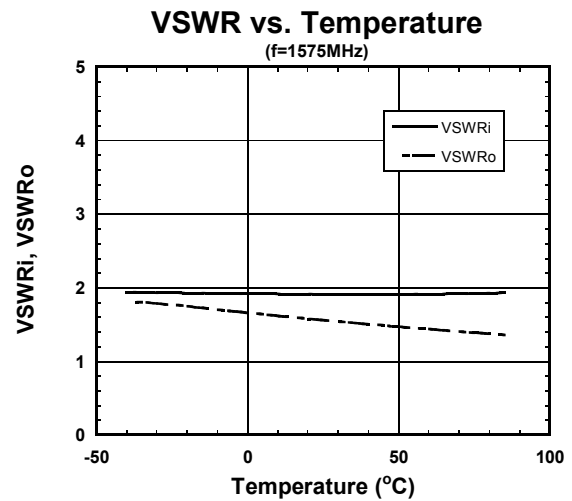
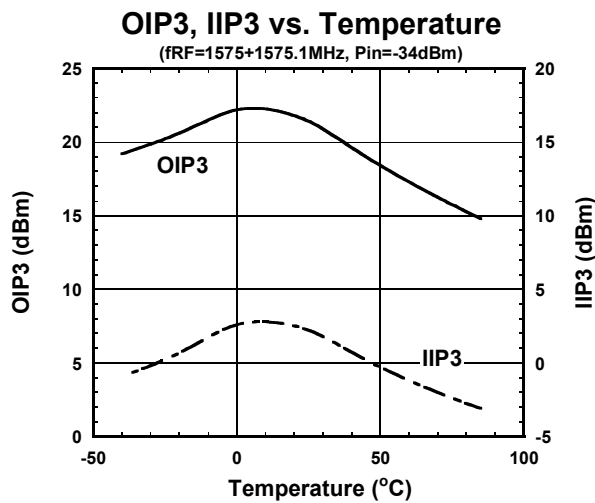
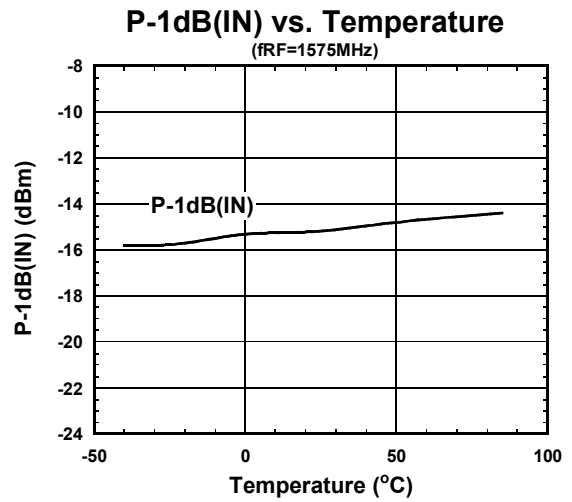
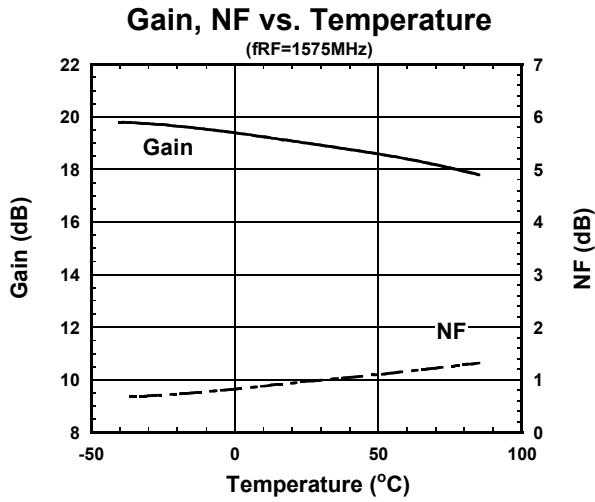

NJG1108HA8

■ ELECTRICAL CHARACTERISTICS

(Conditions: $V_{DD}=V_{INV}=2.7V$, $V_{CTL}=1.85V$, $f_{RF}=1575MHz$, $T_a=+25^{\circ}C$, $Z_s=Z_l=50ohm$, with application circuit)

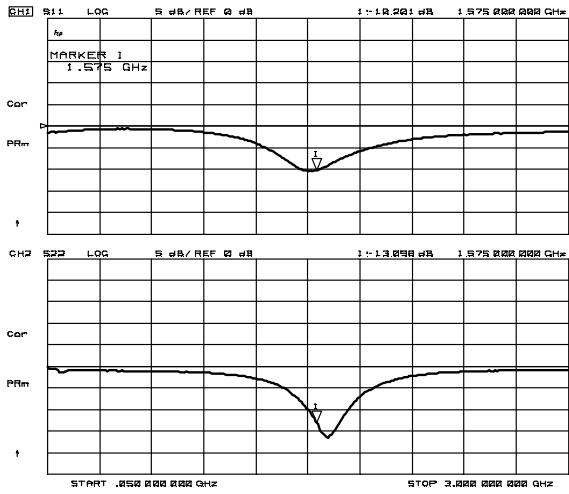

S11, S22

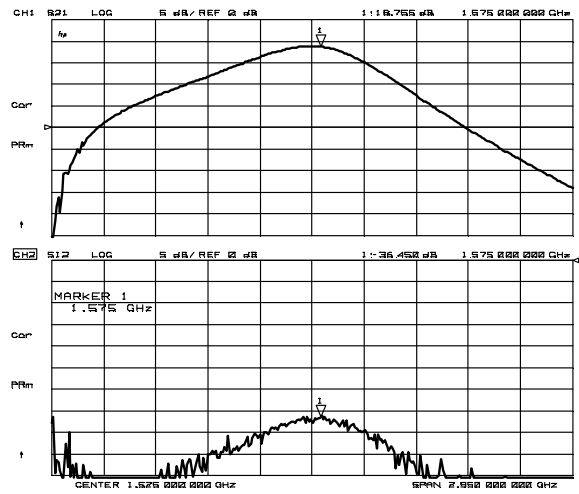

S21, S12

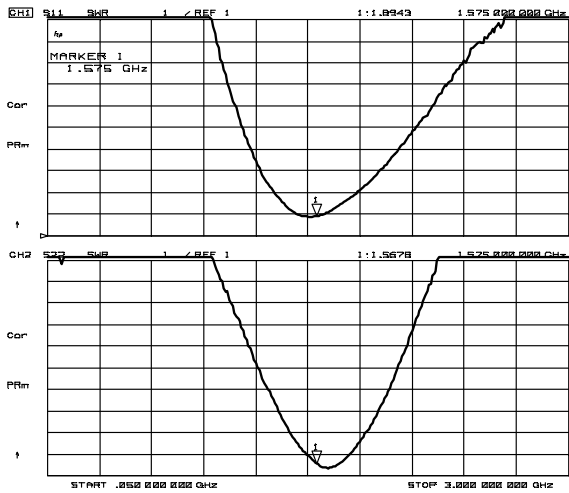

VSWR

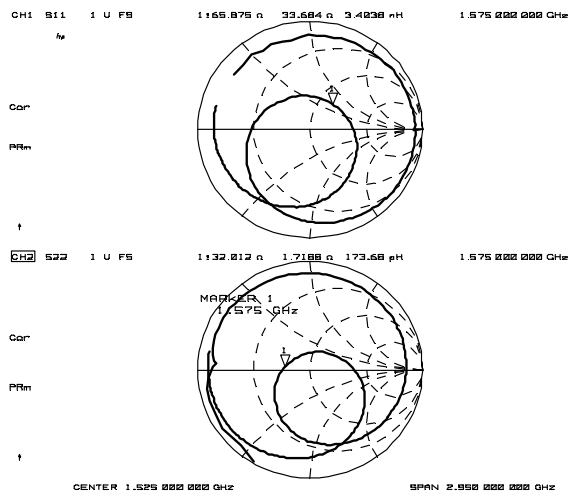

Zin, Zout

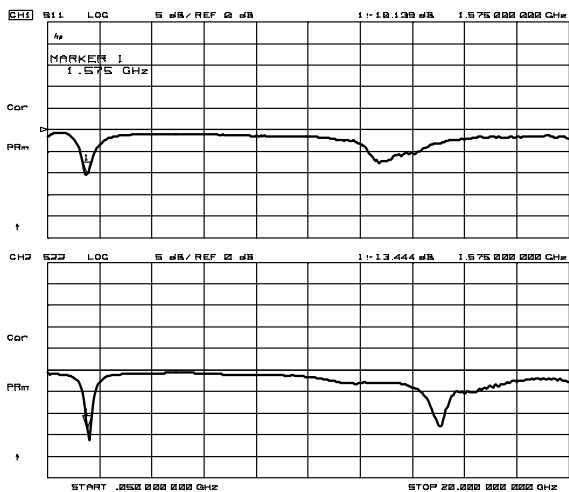

S11, S22 (f=50MHz~20GHz)

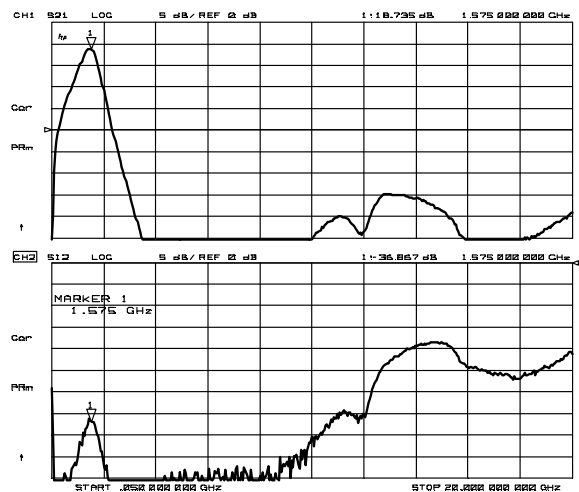

S21, S12 (f=50MHz~20GHz)

APPLICATION CIRCUIT

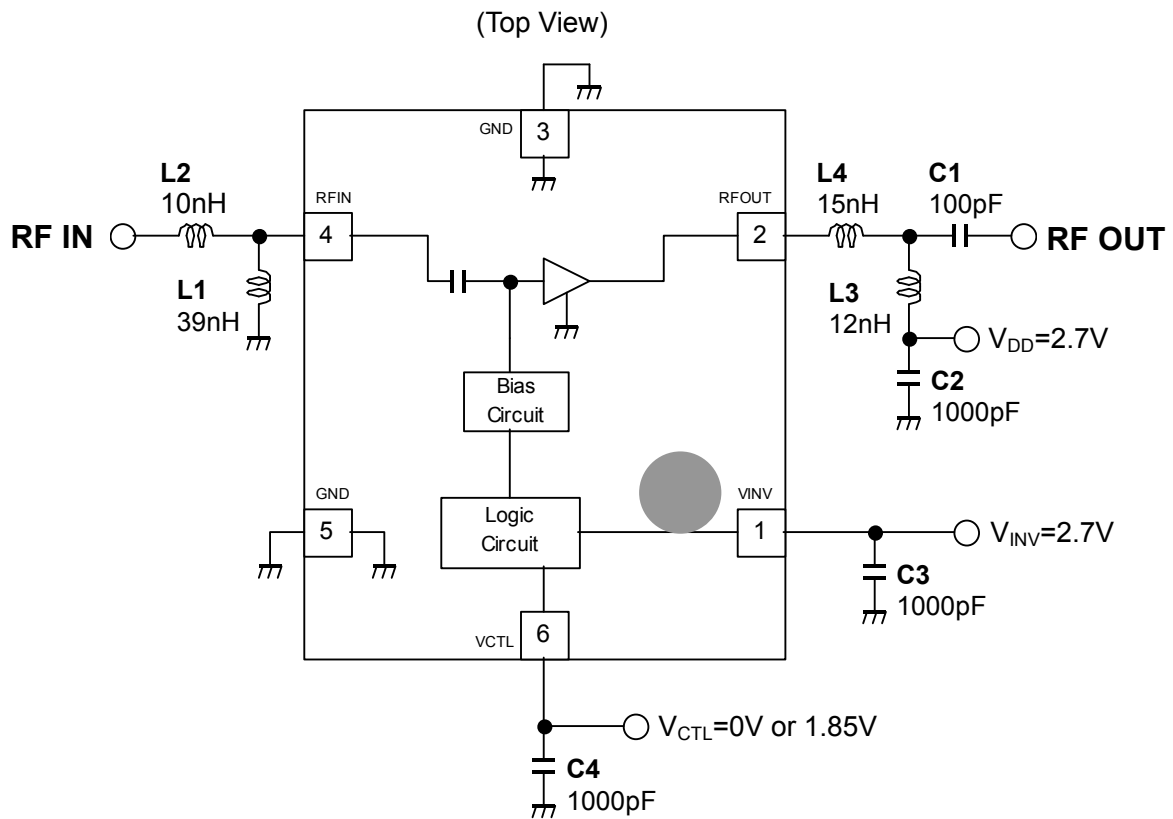

TEST PCB LAYOUT

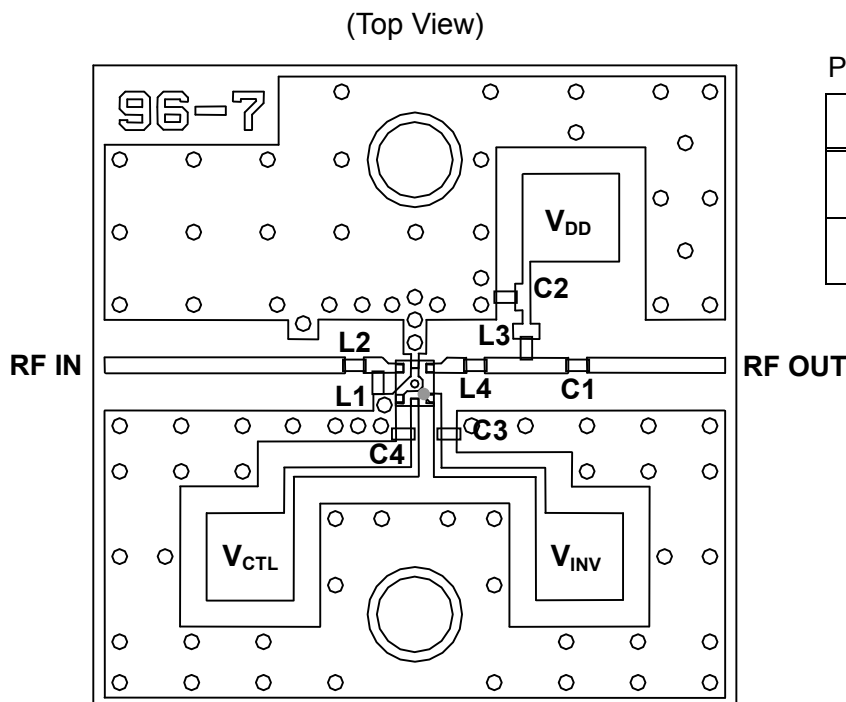

Parts List

Parts ID	Notes
L1~L4	MURATA (LQP03T series)
C1~C4	MURATA (GRM03 series)

PCB (FR-4): t=0.2mm
 MICROSTRIP LINE WIDTH
 =0.4mm ($Z_0=50\text{ohm}$)
 PCB SIZE=17.0mmx17.0mm

NJG1108HA8

PACKAGE OUTLINE (USB6-A8)

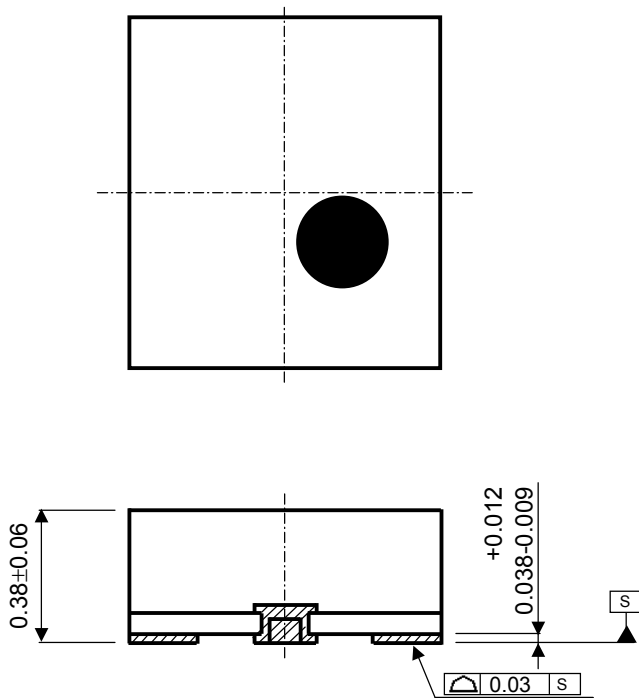

TERMINAL TREAT :Au
 Substrate :FR5
 Molding material :Epoxy resin
 UNIT :mm
 WEIGHT :1.1mg

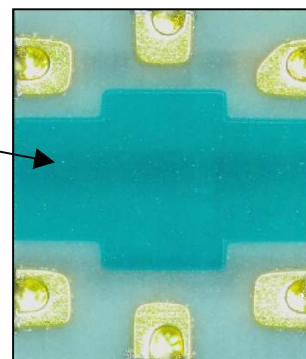
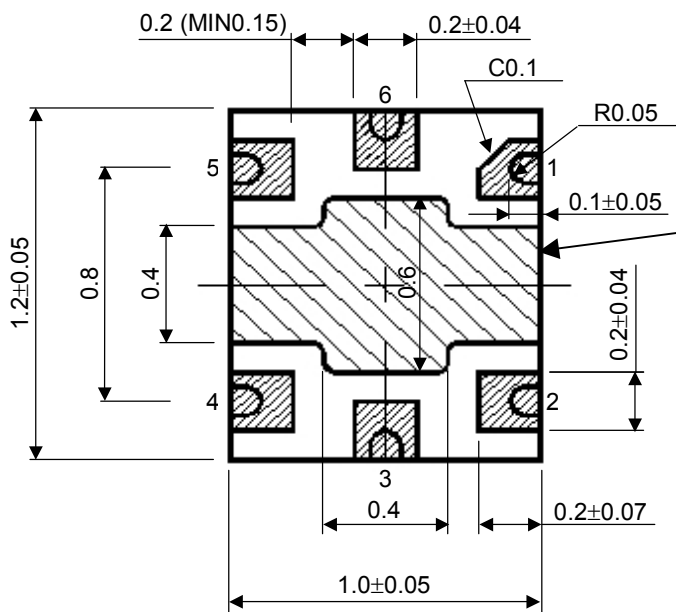

Cautions on using this product

This product contains Gallium-Arsenide (GaAs) which is a harmful material.

- Do NOT eat or put into mouth.
- Do NOT dispose in fire or break up this product.
- Do NOT chemically make gas or powder with this product.
- To waste this product, please obey the relating law of your country.

[CAUTION]

The specifications on this databook are only given for information, without any guarantee as regards either mistakes or omissions. The application circuits in this databook are described only to show representative usages of the product and not intended for the guarantee or permission of any right including the industrial rights.

This product may be damaged with electric static discharge (ESD) or spike voltage. Please handle with care to avoid these damages.